

# IPR512 GPRS/IP Monitoring Receiver V2.0

**P** **▲** **R** **▲** **D** **▲** **O** **X**<sup>®</sup>  
S E C U R I T Y   S Y S T E M S



## Operations Manual

## **Warranty**

Paradox Security Systems Ltd. ("Seller") warrants its products to be free from defects in materials and workmanship under normal use for a period of one year. Except as specifically stated herein, all express or implied warranties whatsoever, statutory or otherwise, including without limitation, any implied warranty of merchantability and fitness for a particular purpose, are expressly excluded. Because Seller does not install or connect the products and because the products may be used in conjunction with products not manufactured by Seller, Seller cannot guarantee the performance of the security system and shall not be responsible for circumstances resulting from the product's inability to operate. Seller obligation and liability under this warranty is expressly limited to repairing or replacing, at Seller's option, any product not meeting the specifications. Returns must include proof of purchase and be within the warranty period. In no event shall the Seller be liable to the buyer or any other person for any loss or damages whether direct or indirect or consequential or incidental, including without limitation, any damages for lost profits stolen goods, or claims by any other party, caused by defective goods or otherwise arising from the improper, incorrect or otherwise faulty installation or use of the merchandise sold.

Notwithstanding the preceding paragraph, the Seller's maximum liability will be strictly limited to the purchase price of the defective product. Your use of this product signifies your acceptance of this warranty.

BEWARE: Dealers, installers and/or others selling the product are not authorized to modify this warranty or make additional warranties that are binding on the Seller.

## **Patents**

One or more of the following US patents may apply: 7046142, 6215399, 6111256, 6104319, 5920259, 5886632, 5721542, 5287111, 5119069, 5077549 and RE39406. Canadian and international patents may also apply.

## **Certification**

For the latest information on product approvals, such as UL and CE, please visit [www.paradox.com](http://www.paradox.com).

# Table of Contents

---

<b>Package Contents</b> .....	<b>5</b>
Included Materials .....	5
Additional Items Required (not included) .....	5
<b>Overview</b> .....	<b>6</b>
IPR512 Receiver System Features .....	6
512 Supervised Paradox Reporting Modules .....	6
Redundant ISP (WAN1/WAN2) .....	6
2 Serial Ports (COM1/COM2) .....	6
Integrated Web Page (LAN).....	6
Data Backup on External Memory Card .....	6
End-to-End Supervision.....	7
Programmable Polling Time and Grace Period .....	7
Firmware Upgradeable .....	7
Other Features.....	7
Paradox Product Compatibility .....	8
Software Compatibility.....	8
IPR512 Receiver System Defaults .....	8
IPR512 Receiver Technical Specifications.....	9
IPR512 Receiver Dimensions .....	9
IPR512 Receiver Overview - Front View.....	10
IPR512 Receiver Overview - Back View .....	11
<b>Installation</b> .....	<b>12</b>
Rack-Mount.....	12
Desk-Mount.....	13
<b>Connection</b> .....	<b>14</b>
Connecting to the COM1 Port .....	14
Connecting to the COM2 Port .....	15
Connecting the LAN Interface .....	15
Connecting the WAN Interfaces.....	16
Installing the Memory Card for Data Backup.....	16
Connecting Power.....	17
Powering up the IPR512 Receiver .....	17
<b>System Configuration</b> .....	<b>18</b>
Accessing the IPR512 Receiver Account Management System.....	18
Registering the IPR512 Receiver .....	20
IPR512 Receiver Account Management System Overview .....	23
Change Password.....	24
Accounts Menu .....	25
Security Profiles Menu .....	28
Receiver Configuration Menu .....	32
Event Configuration Menu .....	35
Receiver Status Menu.....	39
View/Restore Deleted Accounts Menu .....	41

- IPR512 Receiver LCD System Configuration ..... 44**
  - Setting the IP Address, Port and Subnet Mask..... 44
- Troubleshooting and Maintenance ..... 46**
  - Troubles Overview ..... 46
  - System Backup Overview ..... 48
  - Firmware Upgrade Overview..... 50
    - Accessing the In-Field Paradox Upgrade Software Application..... 50
- Initiating Communication with the IPR512 Receiver ..... 59**
  - Registering the Paradox Reporting Modules..... 59
- Index ..... 60**

# Chapter 1: Package Contents

---

This chapter outlines the package contents provided with your Paradox IPR512 GPRS/IP Monitoring Receiver.

## Included Materials

Please verify that you have received the following items with your package. If any materials are missing or damaged, please contact your local Paradox dealer.

Your package includes the following items:

- Paradox IPR512 GPRS/IP Monitoring Receiver
- 2GB Memory Card
- 1.8 meter (6-foot) power cable
- 3 meter (10-foot) DB25 to DB9 serial cable
- Gender changer
- Rack-Mounting Kit (includes brackets and screws)
- Desktop Installation Kit (includes mounting feet and screws)
- Removable connector for Input/Output Relay

## Additional Items Required (not included)

- CAT5 network cable for Local Area Network (LAN) and Wide Area Network (WAN1 and WAN2)
- Optional: DB9 or DB25 serial cable (RS-232)
- Router and computer on a secured network to access internal web page interface (LAN)
- Network router with internet access

## Chapter 2: Overview

---

This chapter provides an overview of the Paradox GPRS/IP Monitoring Receiver. It covers system features, technical specifications, software compatibility and an overview of the IPR512 Receiver components.

### IPR512 Receiver System Features

The IPR512 Receiver allows up to 512 supervised Paradox control panels with a Paradox reporting module (PCS200/IP100) to report system events over an IP network. These events are then transmitted to the automation software of the monitoring station. All this is achieved through proprietary encrypted communication using AES 256-bit encryption between the control panel, the Paradox reporting module, and the IPR512 Receiver. The IPR512 Receiver also supervises all 512 connections (control panel presence and IP communication) at a configured rate.

#### 512 Supervised Paradox Reporting Modules

The IPR512 Receiver provides high-speed supervision for up to 512 Paradox control panels using a Paradox reporting module. Each Paradox reporting module can report multiple partitions.

#### Redundant ISP (WAN1/WAN2)

2 Ethernet ports (WAN1 and WAN2) to receive events through two different Internet Service Providers (ISPs).

#### 2 Serial Ports (COM1/COM2)

COM1: connects to Automation Software (used by monitoring station) by emulating the communication protocol selected for event reporting.

COM2: connects to a serial printer or a PC that supports plain text viewing of RS-232 serial communication.

#### Integrated Web Page (LAN)

LAN port to configure IPR512 Receiver via web page interface used to view, edit and delete Paradox reporting modules, edit polling profiles, configure receiver, view receiver troubles, and program special event report codes.

#### Data Backup on External Memory Card

The receiver has a built-in flash memory card slot for data backup and recovery. This allows fast and easy substitution of receiver units in crash recovery situations. Uses external SD, SD/HC, or MMC memory cards.

## End-to-End Supervision

The entire communication line (control panel, internet module, receiver and automation software) is fully supervised and can be reported due to Paradox's proprietary encrypted communication.

## Programmable Polling Time and Grace Period

Up to 32 security profiles can be created per receiver with a programmable polling time and grace period (seconds, minutes, or hours). If the receiver does not receive a presence message from the internet module within the polling time, the receiver will then wait until the grace period elapses before reporting a supervision loss to the monitoring station's automation software.

## Firmware Upgradeable

The receiver is firmware upgradeable in less than 90 seconds and features automatic update\* verification.

\* Automatic firmware upgrade not supported by current version. Please check the web for updates.

## Other Features

- Supports CID and SIA reporting formats
- 256-bit AES data encryption
- 2-line, 40-character LCD with a 6-button interface to view troubles, backup data to/from memory card, set IP Address and Subnet Mask for LAN port, and backlight and contrast
- Supports 19" rack mounting (1U) or desktop installation
- Output relay (triggered by selected events)†
- Input relay (sends selected events when triggered)†
- Automatic date and time synchronization via Network Time Protocol (NTP)
- Robust and durable construction
- Standard 110/220Vac power supply
- Extremely low noise and low power consumption (less than 10W)
- Secure private operating system

† Input/output relay not supported by current version. Please check the web for updates. When the feature is available, the input/output relay must be installed in the same room as the IPR512 GPRS/IP Monitoring Receiver.

**Figure 1: IPR512 Receiver Overview**

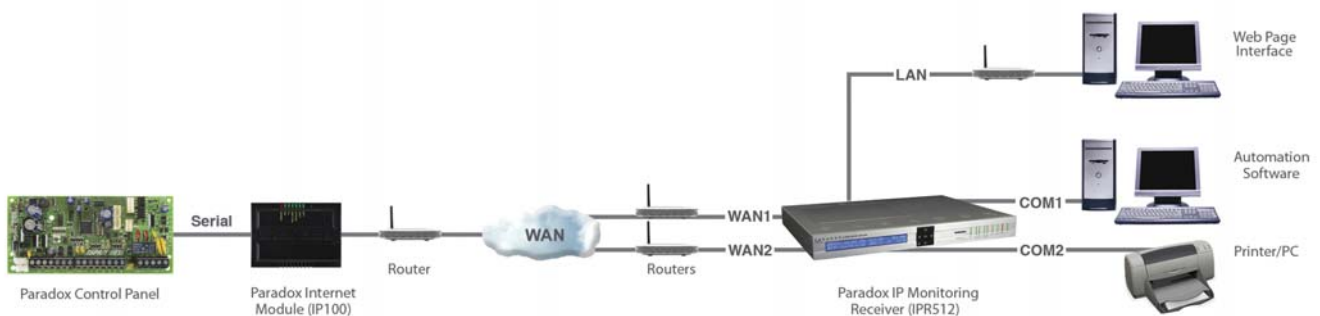

## Paradox Product Compatibility

The IPR512 Receiver is compatible with the following Paradox security products:

- IP100 V1.50 or higher
- PCS200 V1.0 or higher
- PCS100 GPRS Module V1.60 or higher
- EVO48 and EVO192 V2.02 or higher with K641/K641R keypads V1.51 or higher
- Spectra SP Series V3.42 or higher with K32LCD keypads V1.22 or higher
- Esprit E65 V2.10 or higher

## Software Compatibility

Monitoring station automation software that support Radionics 6500, Ademco 685, and Sur-Gard MLR2-DG receiver data formats are supported by the IPR512 Receiver interface. The IPR512 Receiver interface is compatible with most automation softwares on the market such as:

- SIS
- SIMS II
- MAXIMUS
- WINSAMM

**Note:** Automation software must be set to generate an audible signal as per UL 1610.

## IPR512 Receiver System Defaults

The following table provides a listing of all factory shipped default settings for the IPR512 Receiver. For more information on configuring the default settings, refer to “IPR512 Receiver LCD System Configuration” on page 44.

**Table 1: IPR512 System Defaults**

	<b>LAN</b>	<b>WAN1</b>	<b>WAN2</b>
IP Address	192.168.1.250	192.168.1.251	192.168.1.252
Port	80 Transmission Control Protocol (TCP)	16000 User Datagram Protocol (UDP)	16001 (UDP)
Subnet Mask	255.255.255.0	255.255.255.0	255.255.255.0
Gateway	192.168.1.1	192.168.1.1	192.168.1.1
DSN Primary	192.168.1.1	192.168.1.1	192.168.1.1
DSN Secondary	192.168.1.1	192.168.1.1	192.168.1.1

The IPR512 Receiver’s default settings can be re-configured through the IPR512 Receiver Account Management System. For more information on how to configure these settings, refer to System Configuration on page 18.



## IPR512 Receiver Technical Specifications

The following table describes the technical specifications of the IPR512 Receiver.

**Table 2: IPR512 Receiver Technical Specifications**

Input Voltage	100-240 VAC (50-60 Hz)
Input Power	10W
Output Voltage	12VDC
Operating Temperature	0°C to +50°C (32°F - 122°F)

## IPR512 Receiver Dimensions

The following table provides the dimensions and weight of the IPR512 Receiver.

**Table 3: IPR512 Receiver Dimensions**

Height	Width	Depth	Weight
4.2 cm (1.66 in.)	42.8 cm (16.84 in.)	30.4 cm (11.96 in.)	3.28 kg (7.2 lbs.)

**Figure 2: IPR512 Receiver Dimensions**

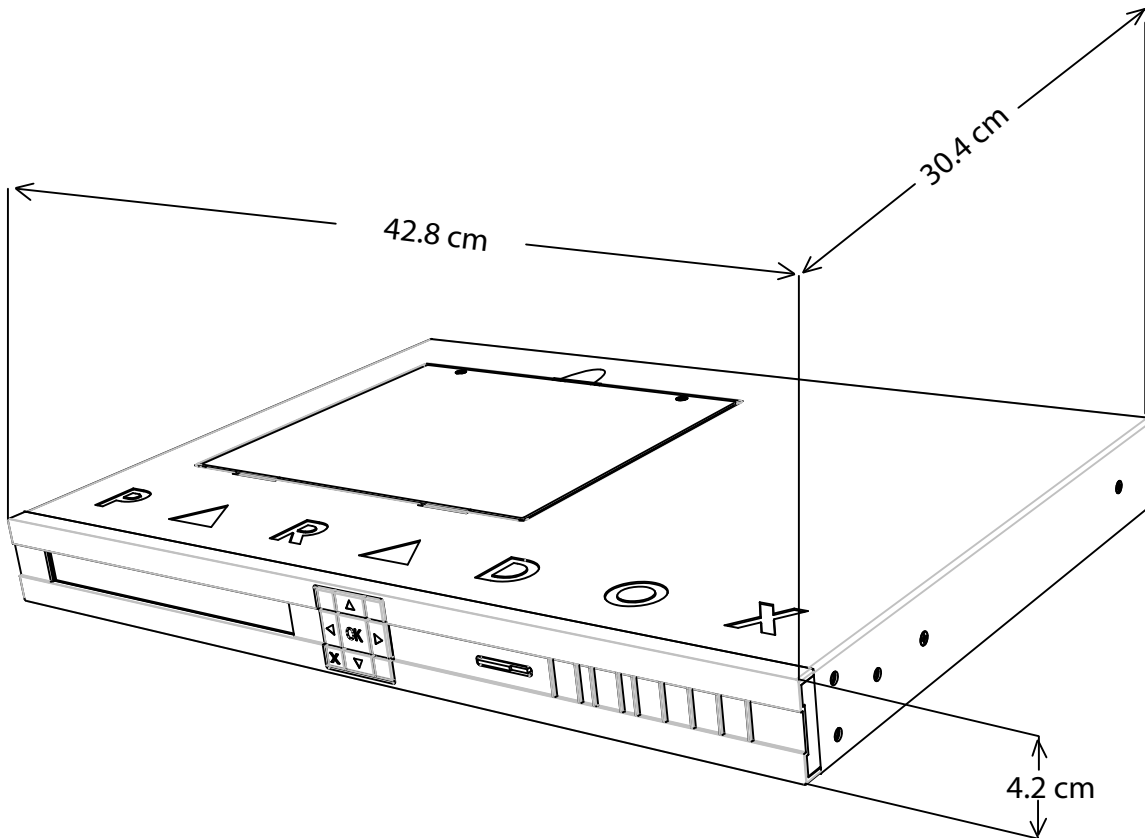

## IPR512 Receiver Overview - Front View

The following provides a description of the IPR512 Receiver system components located in the front of the unit.

**Figure 3: IPR512 Receiver Front View**

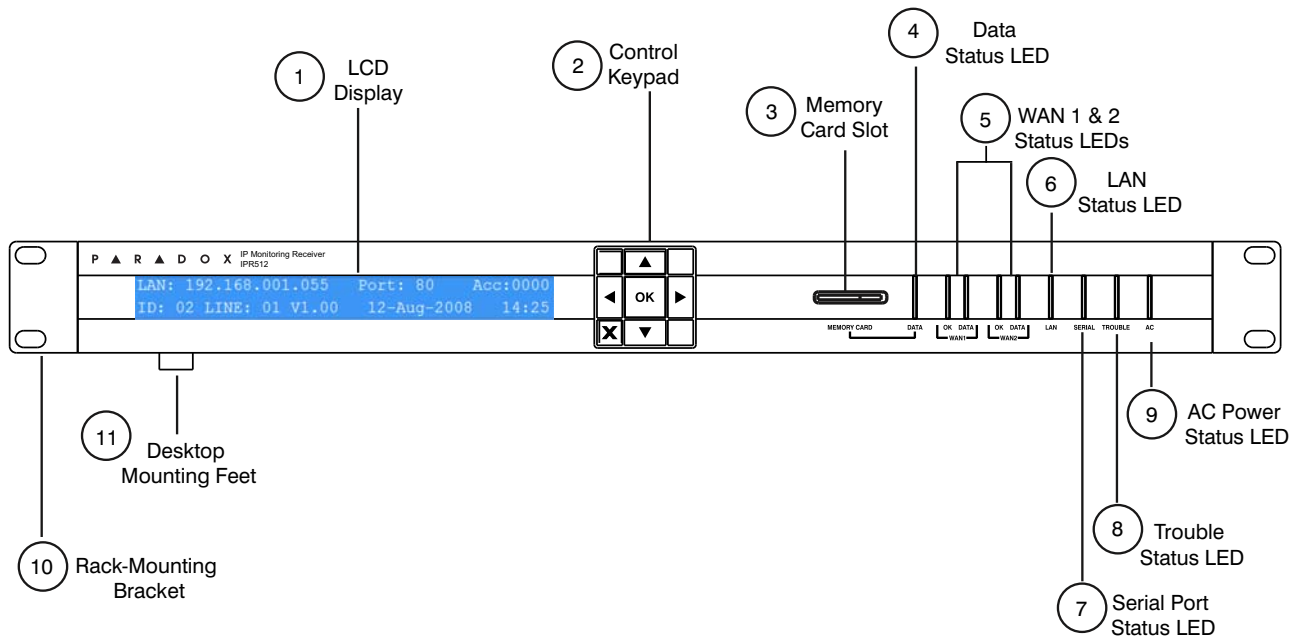

**Table 4: IPR512 Receiver Front View Components**

#	Item	Description
1	LCD Display	A 40-character Liquid Crystal Display (LCD) screen used to display IPR512 Receiver status and modify system settings. For more information, refer to "IPR512 Receiver LCD System Configuration" on page 44.
2	Control Keypad	Used to navigate the status display screen and setting menus of the IPR512 Receiver.
3	Memory Card Slot	Used to store backup data and system configuration information for the IPR512 Receiver. For more information, refer to "Installing the Memory Card for Data Backup" on page 16.
4	Data Status LED	On when memory card is accessed.
5	WAN1 and WAN2 Status LEDs	OK LED - On when WAN1 or WAN2 interface is connected to a network. DATA LED - On when sending or receiving data.
6	LAN Status LED	On when LAN interface is connected to a network.
7	Serial Port Status LED	On when IPR512 Receiver is communicating with the automation software (ACK/NACK).
8	Trouble Status LED	On when IPR512 Receiver is experiencing problems. For more information on the Trouble Status LED, refer to "Troubleshooting and Maintenance" on page 46.
9	AC Power Status LED	On when AC power is present.
10	Rack-Mounting Bracket	Optional mounting hardware used to install the IPR512 Receiver on a standard 19" (48.3 cm) rack. For more information, refer to "Rack-Mount" on page 12.
11	Desktop Mounting Feet	Optional mounting hardware used to install the IPR512 Receiver on a desk or similar type surface. For more information, refer to "Desk-Mount" on page 13.

For more information on the IPR512 Receiver Status LEDs, refer to "Troubleshooting and Maintenance" on page 46.

## IPR512 Receiver Overview - Back View

The following provides a description of the IPR512 Receiver system components located in the back of the unit.

**Figure 4: IPR512 Receiver Back View**

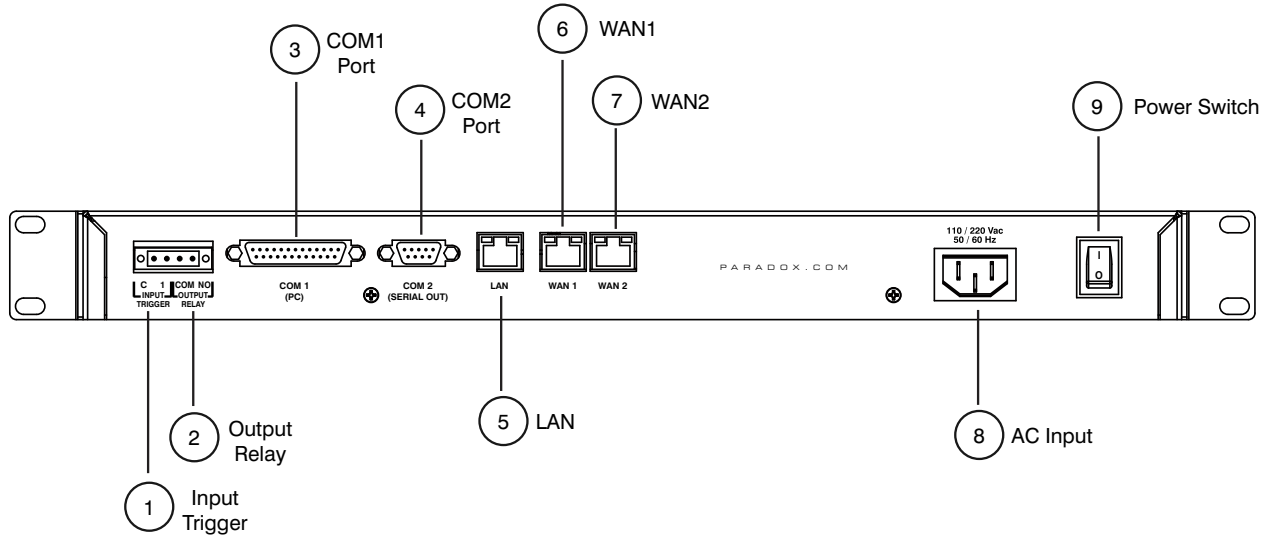

**Table 5: IPR512 Receiver Back View Components**

#	Item	Description
1	Input Trigger*	Dry contact relay used to generate an event that can be reported to the automation software.
2	Output Relay*	Dry contact relay used to activate an external device.
3	COM1 Port	Serial port used to connect the IPR512 to a PC running the automation software.
4	COM2 Port	Serial port used to send events to serial printer or to a PC running a RS-232 serial communication program.
5	LAN	LAN port used to connect to a LAN or directly to a PC for configuration of the IPR512 Receiver.
6	WAN1	Ethernet port used to receive events through an Internet Service Provider (ISP).
7	WAN2	Ethernet port used to receive events through an Internet Service Provider (ISP).
8	AC Input	Provides AC power to the IPR512 Receiver.  <b>Note:</b> Compatible with multiple types of outlets. Contact your local distributor for more information.
9	Power Switch	Powers up the IPR512 Receiver.

For more information on IPR512 Receiver connections, refer to "Connection" on page 14.

\* Input/output relay not supported by current version. Please check the web for updates. When the feature is available, the input/output relay must be installed in the same room as the IPR512 GPRS/IP Monitoring Receiver.

## Chapter 3: Installation

---

This chapter guides you through the steps required to install the IPR512 Receiver. It provides you with the necessary tools and guidelines used in mounting the unit. The IPR512 Receiver package includes a Rack-Mounting Kit and a Desktop Installation Kit.

### Rack-Mount

The IPR512 Receiver can be mounted on a 19" (48.3 cm) rack. Prior to mounting the IPR512 Receiver, ensure that the rack is securely anchored. The appropriate anchoring hardware should be used for your site.

#### Required Materials:

- Rack-Mounting Installation Kit (included)
- Phillips or Flat Head screwdriver

#### Guidelines

- Ensure that at least 1U is allocated on the rack for the IPR512 Receiver.
- Distribute the weight evenly on the rack.
- Ensure a clear path behind the receiver for wiring.

#### To Rack-Mount the IPR512 Receiver

1. Secure the Rack-Mounting Brackets to the IPR512 Receiver, as shown in Rack-Mounted IPR512 Receiver.
2. Slide the unit into the 19" (48.3 cm) rack.
3. Secure with appropriate rack hardware (not included).

**Figure 5: Rack-Mounted IPR512 Receiver**

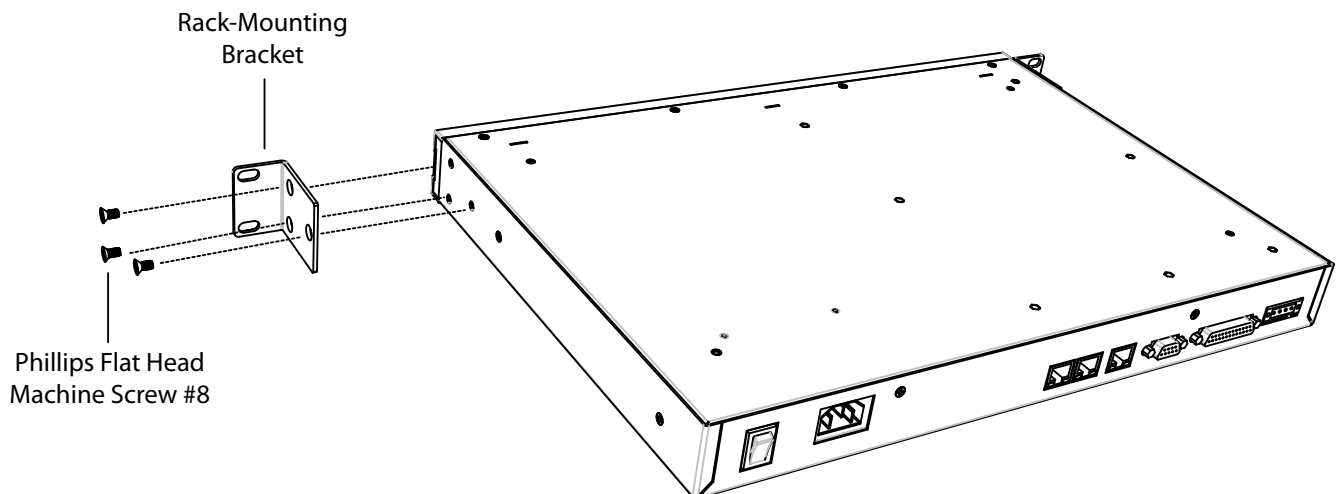

## Desk-Mount

The IPR512 Receiver can be mounted on a desk. Prior to mounting the unit, ensure that the surface is free of any obstacles.

Required Materials:

- Desktop Installation Kit (included)
- Phillips screwdriver

Guidelines

- Ensure that at least 1U is allocated for the IPR512 Receiver.
- Ensure surface for desk-mount installation is stable.
- Ensure a clear path behind the receiver for wiring.

### To Desk-Mount the IPR512 Receiver

1. Secure Desktop Mounting Feet to the IPR512 Receiver, as shown in Desk-Mounted IPR512 Receiver.
2. Position IPR512 Receiver on desk, ready for wiring.

**Figure 6: Desk-Mounted IPR512 Receiver**

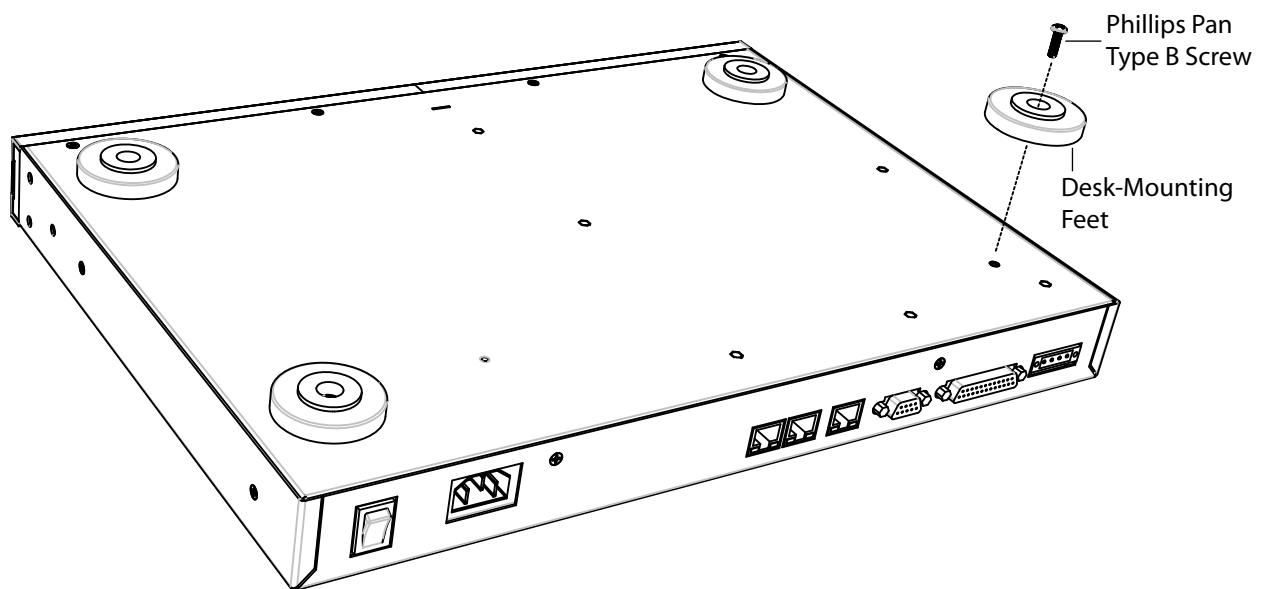

## Chapter 4: Connection

This chapter guides you through the steps required to connect the IPR512 Receiver to your network and how to power-up the unit. The IPR512 Receiver connects to your network providing supervision for up to 512 Paradox control panels.

### Connecting to the COM1 Port

The COM1 Port provides the connection from the IPR512 to the PC running the monitoring station automation software. Its dedicated port output can be supervised through the ACK/NACK protocol. The IPR512 Receiver is software compatible with monitoring station automation software using Radionics 6500, Ademco 685, and Sur-Gard MLR2-DG reporting formats. For more information, refer to “Software Compatibility” on page 8.

#### To connect to the COM1 Port

1. Connect the 3-meter (10-foot) DB25 connector to the COM1 (PC) port on the IPR512 Receiver.
2. Connect the other end of the cable to the COM Port of the PC or on the PC's serial hub.

**Figure 7: COM1 Port Connection**

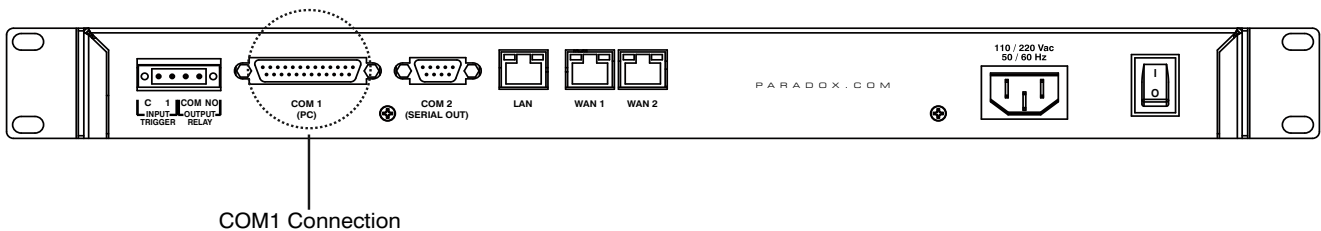

## Connecting to the COM2 Port

The COM2 Port provides the connection to a serial printer or to a PC running a RS-232 serial communication program. The IPR512 Receiver sends reported events in plain text format through the COM2 (RS-232) port, which can be printed or viewed on screen.

### To connect to the COM2 Port

1. Connect the RS-232 cable's DB9 connector to the COM2 (Serial Out) port on the IPR512 Receiver.
2. Connect the other end of the cable to the COM Port of the printer or PC.

**Note:** A gender changer is included for connecting to the COM port of the PC.

**Figure 8: COM2 Port Connection**

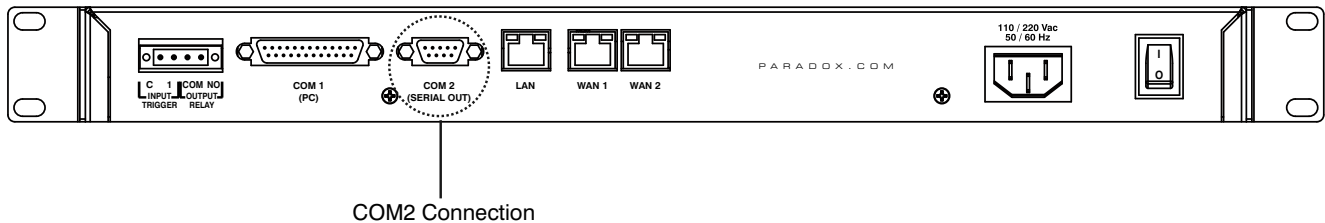

## Connecting the LAN Interface

The LAN Port provides the connection to the IPR512 Receiver in order to access the receiver through a Web page interface for configuration. This interface allows the user to view, edit and delete Paradox reporting modules, edit security profiles, configure the IPR512 Receiver, and program special event report codes. For more information on configuring these settings, refer to "IPR512 Receiver Account Management System Overview" on page 23.

### To connect to the LAN Port

1. Connect a CAT5 network cable to the LAN Port on the IPR512 Receiver.
2. Connect the other end of the cable to the router of the network.

**Note:** The router must be installed in the same room as the IPR512 GPRS/IP Monitoring Receiver.

**Figure 9: LAN Port Connection**

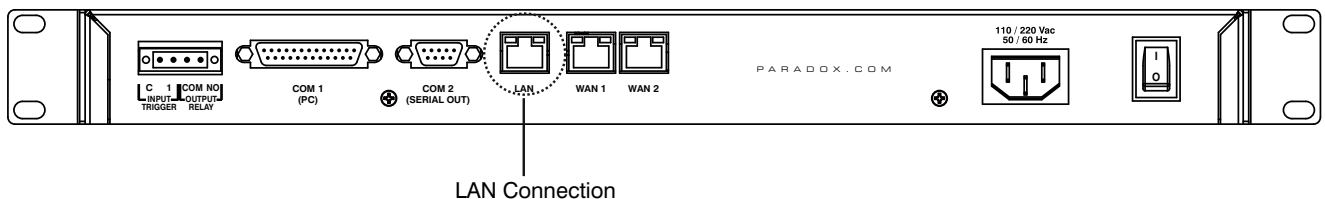

## Connecting the WAN Interfaces

Each IPR512 Receiver provides two WAN ports. Each port can be programmed with its own IP address, thus enabling the IPR512 Receiver to receive events through two different Internet Service Providers (ISPs).

### To connect to the WAN Ports

1. Connect a CAT5 network cable to the WAN port on the IPR512 Receiver.
2. Connect the other end of the cable to the router with internet access on a secured network.

**Note:** The router must be installed in the same room as the IPR512 GPRS/IP Monitoring Receiver.

**Figure 10: WAN Port Connections**

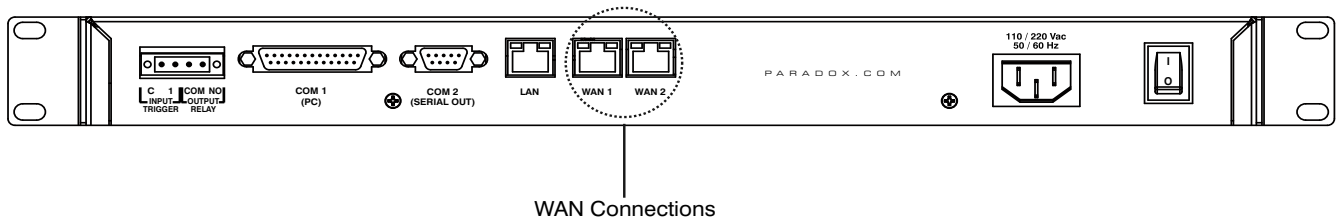

## Installing the Memory Card for Data Backup

The memory card provides up to 10 data backups which are automatically performed 10 minutes after a change has been made in the database or on demand (manually) through the LCD and 6-Button Keypad Interface, for more information, refer to "IPR512 Receiver LCD System Configuration" on page 44. Stored data includes the receiver's network, option and serial configuration settings, profile and user information, and system account information for all 512 accounts. For more information on configuring data backups, refer to "Receiver Configuration Menu" on page 32.

A 2GB memory card is included in your package for system backups. The IPR512 Receiver is compatible with the following types of memory cards:

- SD
- SD/HC
- MMC

### To install the Memory Card

1. Insert memory card into the Memory Card Slot located in the front of the IPR512 Receiver (contacts of the memory card should face the bottom).
2. Push on the card until it is inserted firmly into the slot. The card pushes out slightly and then locks into place.

**Figure 11: Memory Card Installation**

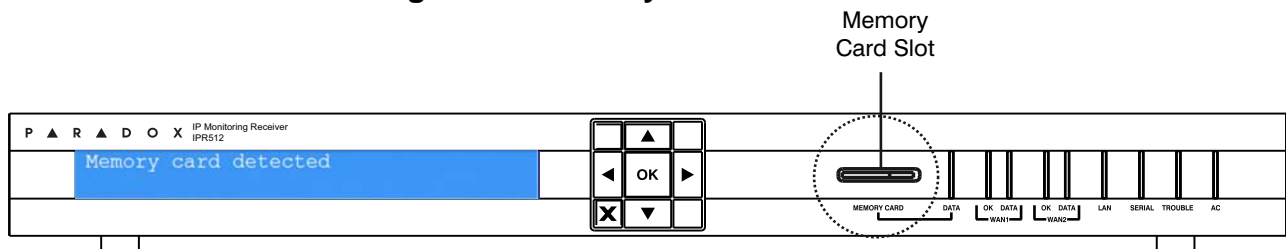



## Connecting Power

The IPR512 Receiver is powered at 100-240 VAC (50-60 Hz) and is compatible with multiple types of electrical outlets. If you require a different type of power cable, contact your local Paradox dealer for more information. For information on technical specifications refer to “IPR512 Receiver Technical Specifications” on page 9.

### To Connect the Power Cable

1. Connect one end of the AC Power cable to the AC Power connector on the IPR512 Receiver.
2. Connect the other end of the power cable to the electrical outlet or UPS source.

**Note:** To comply with applicable UL and CSA requirements, a Belkin Surge Protector (part number F9H120-CW) must be used between the IPR512’s AC power cable and the electrical outlet or UPS source.

**Figure 12: AC Power Connection**

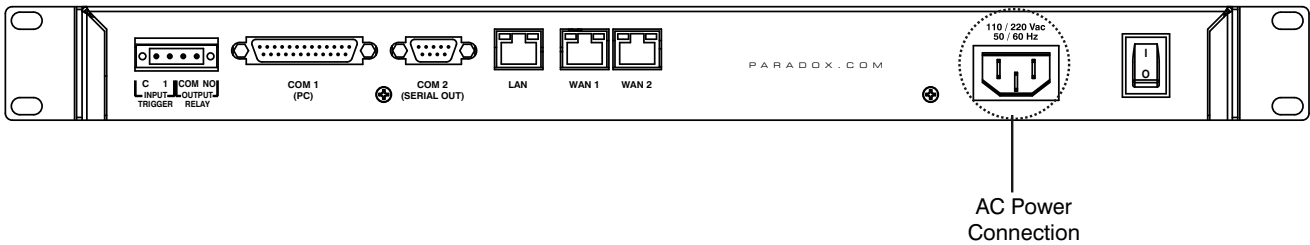

## Powering up the IPR512 Receiver

When all connections have been completed, turn on the IPR512 Receiver by positioning the On/Off switch to the On position. The IPR512 Receiver will go through an initialization process.

**Figure 13: IPR512 Receiver Power-Up**

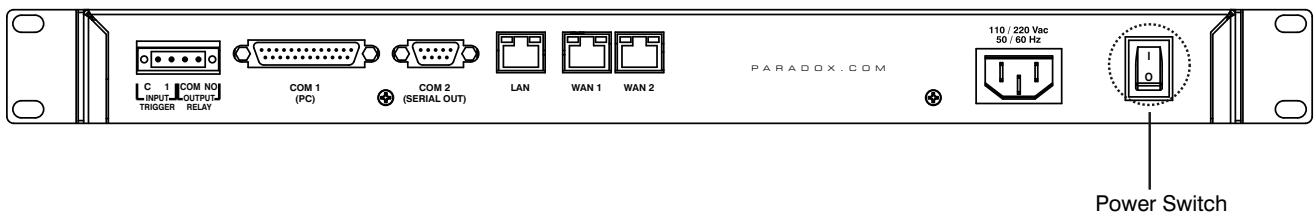

During the IPR512 Receiver’s initialization process, the LCD displays the following messages:

- Message 1 - “Loading data from receiver”.
- Message 2 - “Memory card detected”.
- Message 3 - Displays the default setting information of the IPR512 Receiver, as shown.

**Figure 14: IPR512 Receiver LCD Display Settings**

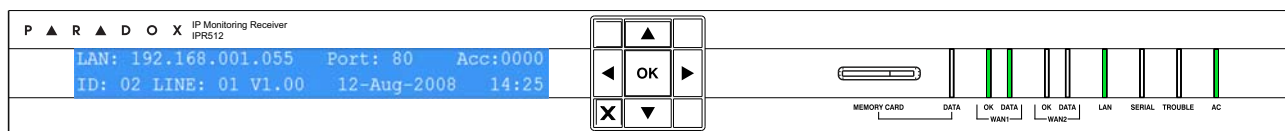

## Chapter 5: System Configuration

---

This chapter guides you through the steps required to configure the IPR512 Receiver through a web browser connection using the IPR512 Receiver Account Management System.

### Accessing the IPR512 Receiver Account Management System

In order to access the IPR512 Receiver Account Management System, the IPR512 must be connected to the same network as the PC. Once a connection has been established configuration settings for your IPR512 Receiver can be set. For more information on how to configure the settings through the LCD menu, refer to “IPR512 Receiver LCD System Configuration” on page 44.

#### To Access the IPR512 Receiver Account Management System

1. Launch your web browser from a computer on the network connected to the IPR512 Receiver's LAN port.
2. Enter the LAN IP address of IPR512 Receiver in the address bar of your web browser. You are now presented at the Login page. Speak to your network administrator to obtain an IP Address and Subnet Mask that will permit access to the IPR512 Receiver on your network.

**Note:** If you cannot connect to the IPR512 Receiver Account Management System, please verify that the LAN IP address was correctly entered into the address bar. If an error page is displayed, the IPR512 Receiver's IP address and Subnet Mask must be changed through the LCD menu on the IPR512 Receiver. For more information on how to change these settings, refer to “IPR512 Receiver LCD System Configuration” on page 44.

**Figure 15: Accessing the IPR512 Receiver Account Management System**



3. Enter your Username. Default username is “admin”.
4. Enter your Password. Default password is “admin”.
5. Click **Login**.

**Note:** When you have logged into the system, it is strongly recommended that the default password be changed for security purposes, note that the username cannot be changed.

**Figure 16: Login Page**

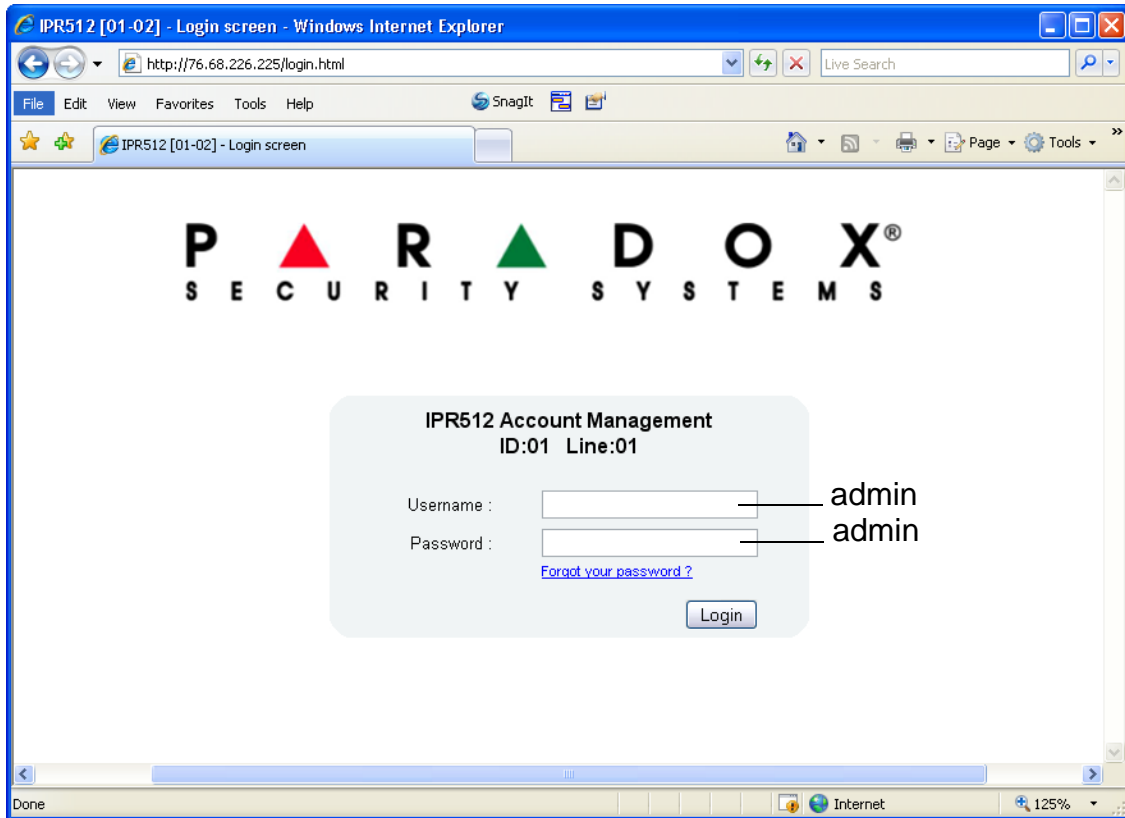

**Table 6: Login Page Fields**

Item	Description
Username	Enter the username. Default username is "admin".
Password	Enter the password. Default password is "admin".
Login	Press to access the IPR512 Receiver Account Management System. Access will only be granted when a valid username and password combination has been entered.
ID	Identifies the ID number of the IPR512 Receiver.
Line	Identifies the line number of the IPR512 Receiver.

## Registering the IPR512 Receiver

After logging into the IPR512 Receiver Account Management System for the first time, you will need to register your IPR512 Receiver in order to activate a fully-functional version. By default, the IPR512 Receiver runs in Demo Mode. When in Demo Mode you are limited to 10 accounts and the communication port COM1 is disabled.

### To Register the Unit

1. Connect the LAN of the IPR512 Receiver to a router on a network with access to the Internet.
2. Click **Register**.

Figure 17: Demo Mode

**DEMO MODE:** By default, your IPR512 IP monitoring receiver runs in demo mode. In demo mode you are limited to 10 accounts, and communication port COM1 is disabled. To activate the fully-functional version, please register your unit. To do so, you must connect the LAN of the receiver to a router on a network with access to the Internet, and then click register.

**Register**

**Main menu**

- Accounts
- Security profiles
- Receiver configuration
- Event configuration
- Receiver status
- View/Restore deleted accounts

[Change password](#)      [Logout](#)     

**Search**

Account # from  to   
 Account #   
 MAC address   
 Show all accounts

**Receiver info**

ID - Line : 01-01  
 Date: 07-Apr-1930  
 Time: 05:35  
 Accounts used: 510 of 10  
 Profiles used: 4 of 32  
 Deleted accounts: 0 of 5

[Troubles occurring](#)

**Accounts**

= Module online       = Module not responding       = Change in process

Account#	MAC address	Security profile	Last poll time	Last IP address	IP device	Panel	Registered on
C000	00:19:BA:FF:C0:00	High Security (5 min)	10/15/08 15:53:58	192.168.1.128	IP100 V1.50	SP5500 V3.42	10/15/08 09:22:54
C001	00:19:BA:FF:C0:01	High Security (5 min)	10/15/08 15:53:58	192.168.1.128	IP100 V1.52	MG5050 V4.14	10/15/08 09:22:55
C002	00:19:BA:FF:C0:02	High Security (5 min)	10/16/08 03:08:26	192.168.1.128	IP100 V1.50	SP5500 V3.42	10/15/08 09:22:56
C003	00:19:BA:FF:C0:03	High Security (5 min)	10/16/08 03:08:22	192.168.1.128	IP100 V1.52	MG5050 V4.14	10/15/08 09:22:57
C004	00:19:BA:FF:C0:04	High Security (5 min)	10/16/08 03:06:27	192.168.1.128	IP100 V1.50	SP5500 V3.42	10/15/08 09:22:58
C006	00:19:BA:FF:C0:06	High Security (5 min)	10/16/08 03:07:30	192.168.1.128	IP100 V1.52	MG5050 V4.14	10/15/08 09:23:00
C007	00:19:BA:FF:C0:07	High Security (5 min)	10/16/08 03:07:21	192.168.1.128	PCS200 V2.01	E55 V2.10	10/15/08 09:23:01
C008	00:19:BA:FF:C0:08	High Security (5 min)	10/16/08 03:07:29	192.168.1.128	PCS200 V1.01	EVO48 V2.10	10/15/08 09:23:02
C009	00:19:BA:FF:C0:09	High Security (5 min)	10/16/08 03:07:16	192.168.1.128	PCS200 V2.01	E55 V2.10	10/15/08 09:23:02
C010	00:19:BA:FF:C0:10	High Security (5 min)	10/16/08 03:07:15	192.168.1.128	PCS200 V1.01	EVO48 V2.10	10/15/08 09:23:04

3. Click on **Create a Login** if this is your first time registering an IPR512 Receiver. If you have already registered a unit, enter your Login ID and Password and then click on **Login**.

**Figure 18: IPR512 Registration Login Page**

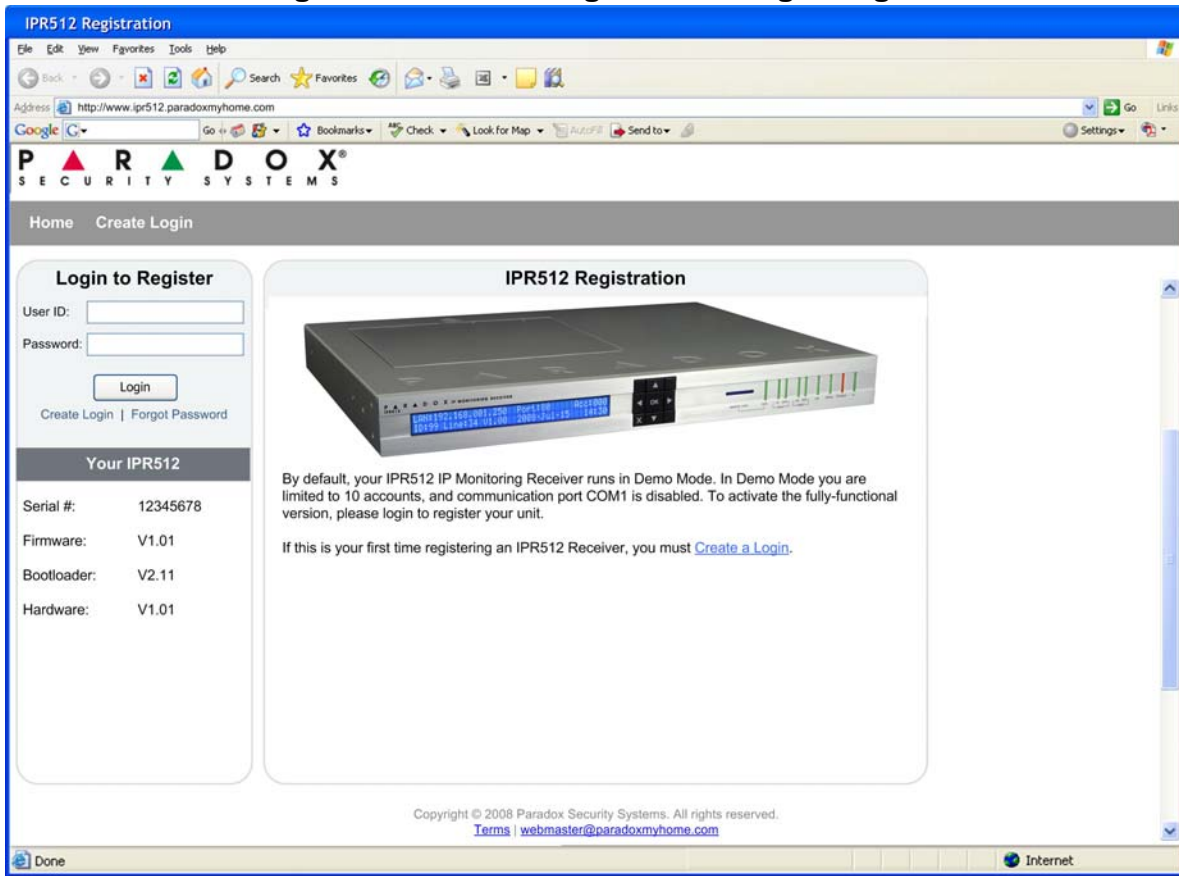

- Click on the **Register** button. The registration process is now complete. The IPR512 Receiver is registered into the system and the IPR512 Receiver Account Management system is now activated and fully-functional. The Registration window displays the Serial #, Firmware, Bootloader and Hardware version of the IPR512 Receiver you are currently registering.

**Note:** The latest firmware version, as well as the most current IPR512 Receiver documentation, can be downloaded from the Registration window.

**Figure 19: Finalizing the Registration**

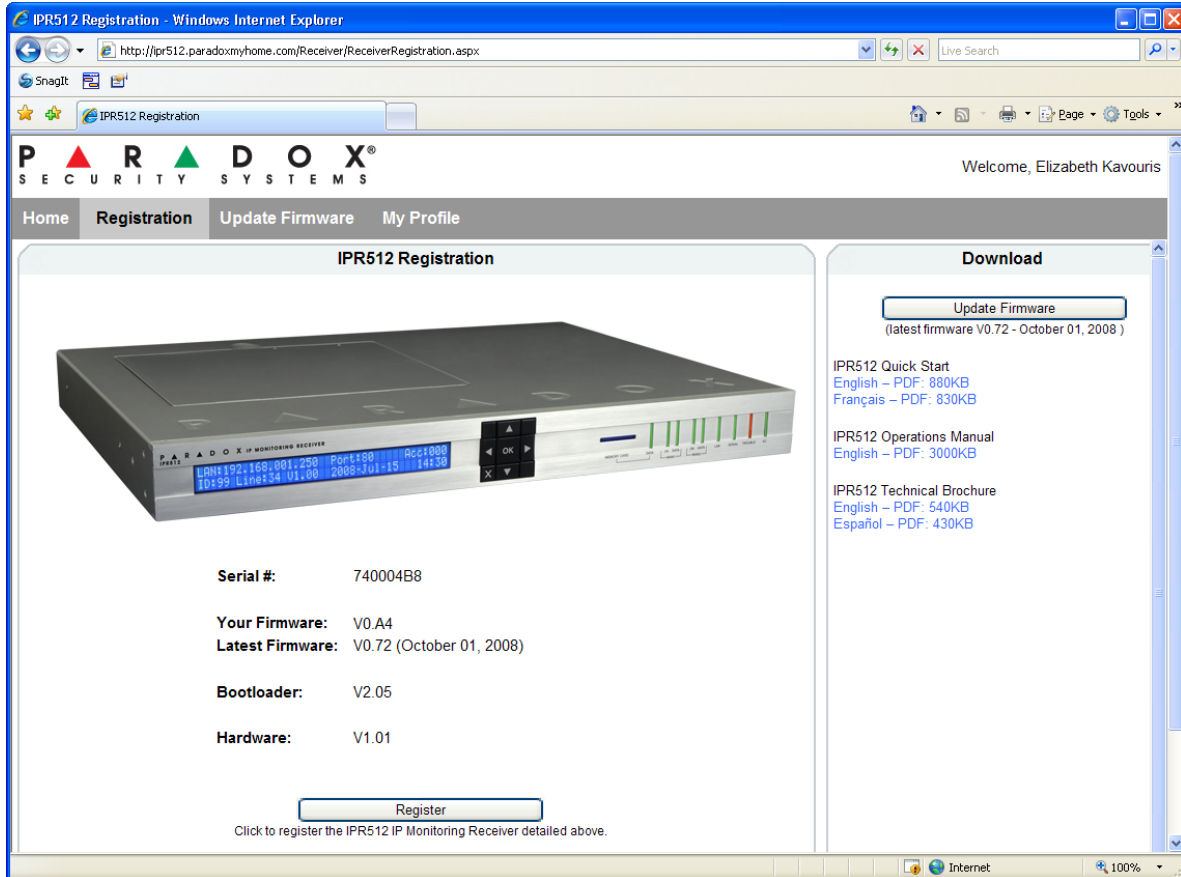

# IPR512 Receiver Account Management System Overview

This section provides an overview of the IPR512 Receiver Account Management System. The IPR512 Receiver Account Management System allows you to configure the receiver's settings, register the unit, upgrade its firmware, view, edit, and delete registered Paradox reporting modules, and setup security profiles.

The Main Menu, Search, and Information views are always displayed at the top of every menu display of the IPR512 Receiver Account Management System. This allows you to view account and profile information at a glance and provides easy access to the search and main menu functions.

**Figure 20: IPR512 Receiver Account Management Overview**

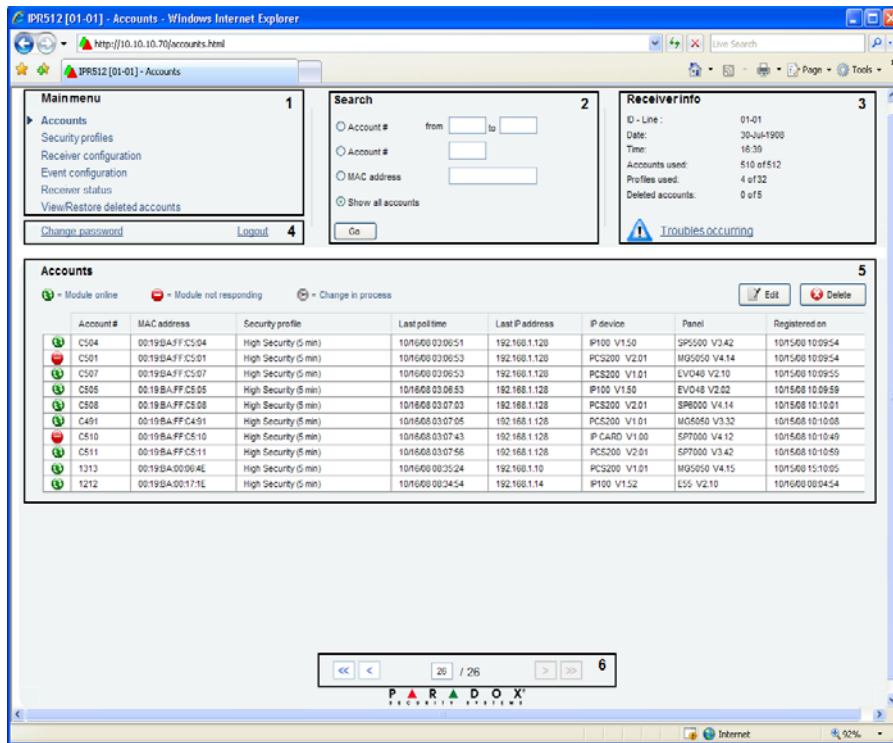

**Figure 21: IPR512 Receiver Account Management System Overview Fields**

Item	Description
1 - Main Menu	Provides access to the following six menu options: <ul style="list-style-type: none"> <li>Accounts - Allows you to access all system accounts.</li> <li>Security Profiles - Allows you to access and define security profiles</li> <li>Receiver Configuration - Allows you to configure settings for the IPR512 Receiver.</li> <li>Event Configuration - Allows you to view account and receiver related events.</li> <li>Receiver Status - Allows you to view the status of the receiver and system information.</li> <li>View/Restore Deleted Accounts - Allows you to view deleted accounts, restore accounts, and permanently delete accounts from the system.</li> </ul>
2 - Search	Provides a search tool that allows you to search by providing a range based on the account number, range of account numbers or by MAC address. Go runs the search.
3 - Receiver Info	Displays the IP Receiver ID and line, date and time, the number of accounts and profiles used in the system, and the number of deleted accounts.
4 - Change Password and Logout	Provides access to the Change Password option and allows you to properly log out of the system.
5- Menu Display	Displays the contents of the selected menu option.
6 - Page Browser	Displays the number of pages. Use the next and previous page arrows to go to desired page. Each page displays a maximum of 20 accounts.

## Change Password

The Change Password option allows you to modify the default login password set in the IPR512 Receiver Account Management System. It is recommended, for security purposes, that the password be changed. To change the password, select the Change password option. You are then able to enter a new password and save your settings.

**Figure 22: Change Password**

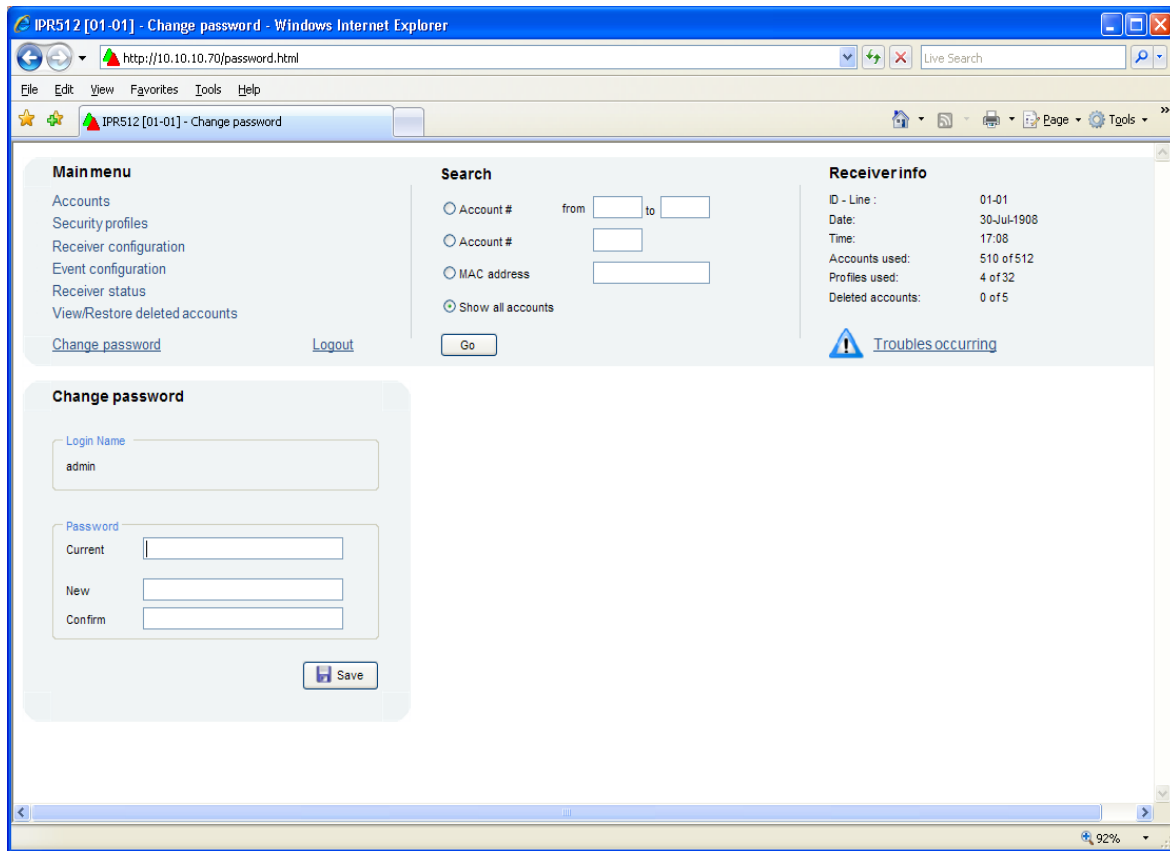

**Table 7: Change Password Fields**

Item	Description
Login Name	Displays current login name.
Current	Enter the current password.
New	Enter the new password (the password can be alphanumeric).
Confirm	Confirm the new password.
Save	Save the new changes.





## Accounts Menu

The Accounts menu option provides access to all registered accounts. From this menu you can modify existing system accounts and assign security profiles.

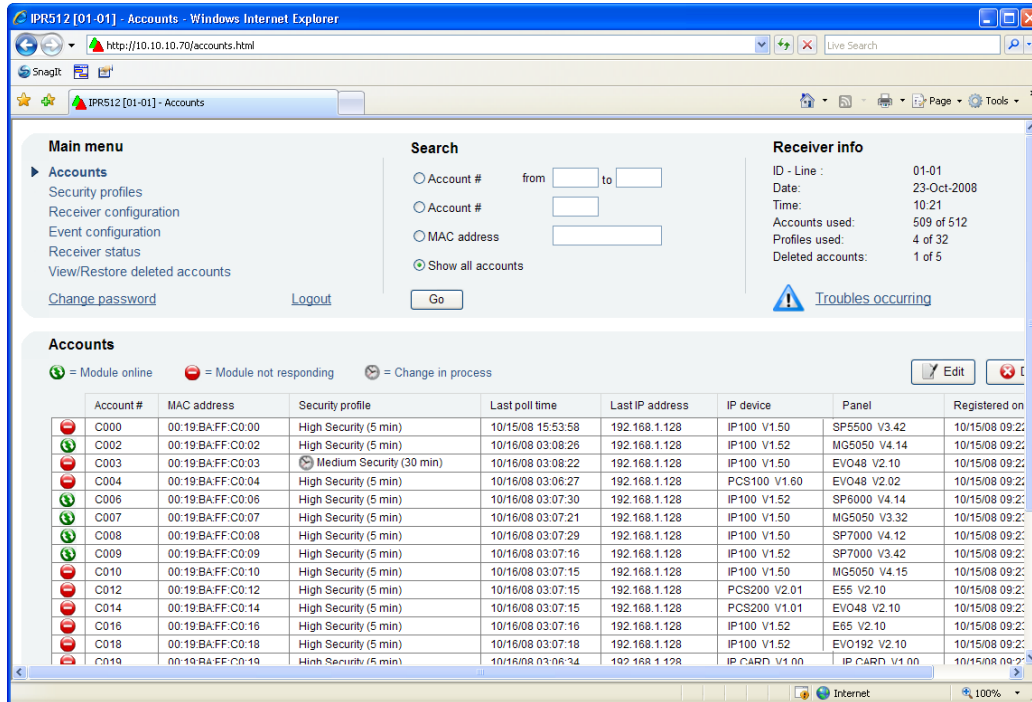
**Figure 23: Account Page**



**Table 8: Account Page Menu Fields**

Item	Description
Status Icon	Displays the current status of the account.   Green - Connection established.  Red - No connection established.  Clock - Change in progress.
Account #	Displays the account number assigned to the current account.
MAC address	Displays the MAC address or unique ID assigned to the Paradox reporting module.
Security profile	Displays the security profile assigned to the current account. For more information on setting the Security profile values, refer to "Security Profiles Menu" on page 28.
Last poll time	Displays the last date and time that the account's IP device sent a presence message to the IPR512 Receiver at the configured Module Polling Time. For more information on setting the Security profile values, refer to "Security Profiles Menu" on page 28.
Last IP address	Displays the IP address of the last IP device that sent a message to the IPR512 Receiver.
IP device	Displays the internet module used at the account site.
Panel	Displays the panel type used at the account site.
Registered on	Displays the time and date of when the module was registered.

## To Modify an Existing Account

1. Select the account you wish to modify from the list.
2. Click on **Edit**.
3. Select the required Security profile from the drop-down list.
4. Click **Save** to save your changes. To cancel any changes without saving, click the **Cancel** option.

**Figure 24: Edit Existing Account**

The screenshot displays a web application interface for managing accounts. The browser title is "IPR512 [99-14] - Accounts - Microsoft Internet Explorer provided by Paradox Security Systems Ltd." The URL is "http://10.10.7.21./accounts.html".

**Main menu:** Accounts, Security profiles, Receiver configuration, Event configuration, Receiver status, View/Restore deleted accounts, Change password, Logout.

**Search:** Account# from [ ] to [ ], Account# [ ], Module ID [ ], Show all accounts (selected), Go.

**Receiver info:** ID - Line: 99-14, Date: 23-Sep-2009, Time: 14:14, Accounts used: 13 of 512, Profiles used: 5 of 32, Deleted accounts: 0 of 5.

**Accounts:** Legend: Module online (green), Module not responding (red), Change in process (grey). Buttons: Edit, Delete.

Account #	Module ID	Security profile	Last poll time	Last IP address	IP device	Panel	Registered on
7337	00:19BA:00:1B:21	Low Security (2 hrs)	06-Nov-08 16:09:36	74.13.249.211	IP100 V1.50	SP5500 V3.42	27-Jan-80 11:09:50
BDE5	00:19BA:00:02:2B	Low Security (2 hrs)	23-Sep-09 14:08:13	10.10.7.166	IP100 V1.52	MG5050 V4.14	31-Jan-35 02:27:47
FDB0	00:19BA:00:21:F2	Low Security (2 hrs)	20-Apr-09 12:16:36	10.10.7.165	IP100 V1.50	EVO48 V2.10	10-Nov-08 12:25:24
4331	00:00:78:FF:FF:FF	Low Security (2 hrs)	02-Dec-08 11:08:35	74.198.110.129	PCS100 V1.60	EVO48 V2.02	11-Nov-08 18:34:20
1122	00:19BA:00:31:41	Low Security (2 hrs)	03-Jun-09 14:29:20	10.10.7.125	IP100 V1.52	SP8000 V4.14	12-Nov-08 11:33:56
3333	00:19BA:00:00:42	Low Security (2 hrs)	13-Nov-08 09:17:00	76.68.225.42	IP100 V1.50	MG5050 V3.32	13-Nov-08 09:16:55
4610	00:19BA:00:1E:52	Medium Security (40 min)	25-Mar-09 10:40:57	10.10.2.59	IP100 V1.50	SP7000 V4.12	13-Feb-09 10:12:34
0030	00:19BA:00:05:A8	Low Security (2 hrs)	16-Feb-09 06:47:27	10.10.1.235	IP100 V1.52	SP7000 V3.42	13-Feb-09 08:10:26
3030	00:19BA:00:17:44	Low Security (2 hrs)	26-May-09 14:43:23	10.10.7.109	IP100 V1.50	MG5050 V4.15	06-Apr-09 11:50:29
5555	00:00:79:00:02:59	Low Security (2 hrs)	01-Jun-09 15:34:33	74.198.110.135	PCS200 V2.01	E55 V2.10	06-Apr-09 15:36:32
1441	00:00:79:00:03:6B	Low Security (2 hrs)	01-Mar-34 05:11:51	74.198.32.124	PCS200 V1.01	EVO48 V2.10	01-Mar-34 03:41:15
5006	00:19BA:00:17:9E	Low Security (2 hrs)	22-Sep-09 11:14:20	76.65.104.253	IP100 V1.52	E65 V2.10	08-Sep-09 11:31:30
5016	00:19BA:00:17:45	Low Security (2 hrs)	23-Sep-09 14:05:16	76.65.104.253	IP100 V1.52	EVO192 V2.10	08-Sep-09 14:32:07

Buttons: Save, Cancel

## To Delete an Existing Account

1. Select the account you wish to delete from the list.
2. Click on **Delete**.
3. Select **Yes** to delete or **No** to cancel your action.

Figure 25: Delete Existing Account

The screenshot shows a web browser window displaying the 'Accounts' management interface. A modal dialog box is open, asking for confirmation to delete account 1122. The interface includes a search bar, a main menu, and a table of accounts. The table has columns for Account#, Module ID, Security profile, IP device, Panel, and Registered on. Account 1122 is highlighted in blue, and its 'Delete' button is active.

Account#	Module ID	Security profile	IP device	Panel	Registered on
7337	00:19:BA:00:1B:21	Low Security (2 hrs)	IP100 V1.50	SP5500 V3.42	27-Jan-80 11:09:50
BDE5	00:19:BA:00:02:2B	Low Security (2 hrs)	IP100 V1.52	MG5050 V4.14	31-Jan-35 02:27:47
FDB0	00:19:BA:00:21:F2	Low Security (2 hrs)	IP100 V1.50	EVO48 V2.10	10-Nov-08 12:25:24
4331	00:00:78:FF:FF:FF	Low Security (2 hrs)	PCS100 V1.60	EVO48 V2.02	11-Nov-08 18:34:20
1122	00:19:BA:00:31:41	Low Security (2 hrs)	IP100 V1.52	SP6000 V4.14	12-Nov-08 11:33:56
3333	00:19:BA:00:00:42	Low Security (2 hrs)	IP100 V1.50	MG5050 V3.32	13-Nov-08 09:16:55
4610	00:19:BA:00:1E:52	Medium Security (40 min)	IP100 V1.50	SP7000 V4.12	13-Feb-09 10:12:34
0030	00:19:BA:00:05:A8	Low Security (2 hrs)	IP100 V1.52	SP7000 V3.42	13-Feb-09 08:10:26
3030	00:19:BA:00:17:44	Low Security (2 hrs)	IP100 V1.50	MG5050 V4.15	06-Apr-09 11:50:29
5555	00:00:79:00:02:59	Low Security (2 hrs)	PCS200 V2.01	E55 V2.10	06-Apr-09 15:36:32
1441	00:00:79:00:03:8B	Low Security (2 hrs)	PCS200 V1.01	EVO48 V2.10	01-Mar-34 03:41:15
5006	00:19:BA:00:17:9E	Low Security (2 hrs)	IP100 V1.52	E65 V2.10	08-Sep-09 11:31:30
5016	00:19:BA:00:17:45	Low Security (2 hrs)	IP100 V1.52	EVO192 V2.10	08-Sep-09 14:32:07

## Security Profiles Menu

The Security Profiles menu option provides up to 32 security profiles that can be created for each IPR512 Receiver. Security profiles are used by the IP device to report presence messages to the IPR512 Receiver at the configured Module Polling Time. If the IPR512 Receiver does not receive a presence message within the configured Receiver Supervision Time, the receiver will report a supervision loss to the monitoring station's automation software. For more information on how to configure a supervision loss, refer to "Event Configuration Menu" on page 35.

Each presence message contains less than 100 bytes of data. When a security profile is modified, the IP device(s) assigned to the profile will automatically be updated during the next Module Polling Time. The following table provides the four security profiles and default polling and supervision times that have been pre-set in the system.

**Table 9: Security Profile System Defaults**

ID	Name	Module Polling Time	Receiver Supervision Time
00	No Supervision	24 hours	None
01	Low Security	20 minutes	2 hours
02	Medium Security	10 minutes	40 minutes
03	High Supervision	2 minute	10 minutes
04	Maximum Security	25 seconds	90 seconds

**Note:** All the pre-set module Polling and Receiver Supervision Times can be re-configured in the system. Paradox strongly recommends that Receiver Supervision Times be configured with a minimum of one minute and that the Module Polling Time be at least half of the Receiver Supervision Time (e.g., RST: 1 minutes - MPT: 30 seconds).

**Figure 26: Security Profiles Menu**

The screenshot shows a web browser window titled "IPR512 [99-14] - Security profiles - Microsoft Internet Explorer provided by Paradox Security Systems Ltd." The address bar shows "http://10.10.7.21./profiles.html". The page content includes:

- Main menu:** Accounts, Security profiles (selected), Receiver configuration, Event configuration, Receiver status, View/Restore deleted accounts, Change password, Logout.
- Search:** Radio buttons for Account#, Account#, and Module ID, with input fields and a "Go" button. The "Show all accounts" option is selected.
- Receiver info:** ID-Line: 99-14, Date: 23-Sep-2009, Time: 13:37, Accounts used: 13 of 512, Profiles used: 5 of 32, Deleted accounts: 0 of 5.
- Security profiles:** A table listing profiles with "Add", "Edit", and "Delete" buttons.

ID	Name	Module polling time	Receiver supervision time	Accounts using this profile
00	No Supervision	24 hours	Not supervised	0 accounts
01	Low Security	20 minutes	2 hours	12 accounts
02	Medium Security	10 minutes	40 minutes	1 accounts
03	High Security	2 minutes	10 minutes	0 accounts
04	Maximum Security	25 seconds	90 seconds	0 accounts

**Table 10: Security Profiles Menu Fields**

Item	Description
ID	Displays the ID assigned to the Security Profile. This ID is used by the field installer when programming the IP device.
Name	Displays the name or description assigned to the Security Profile.
Module Polling Time	Displays the polling time assigned to the Security Profile.
Receiver Supervision Time	Displays the time assigned before reporting a supervision loss to the monitoring station's automation software.
Accounts using this profile	Displays the number of accounts to which this security profile is assigned.

**To Add a Security Profile**

1. Click **Add**.
2. Define the name, Module Polling Time and Receiver Supervision Time.
3. Click **Save** to save your changes. To cancel any changes without saving, select the **Cancel** option.

**Figure 27: Add New Security Profile**

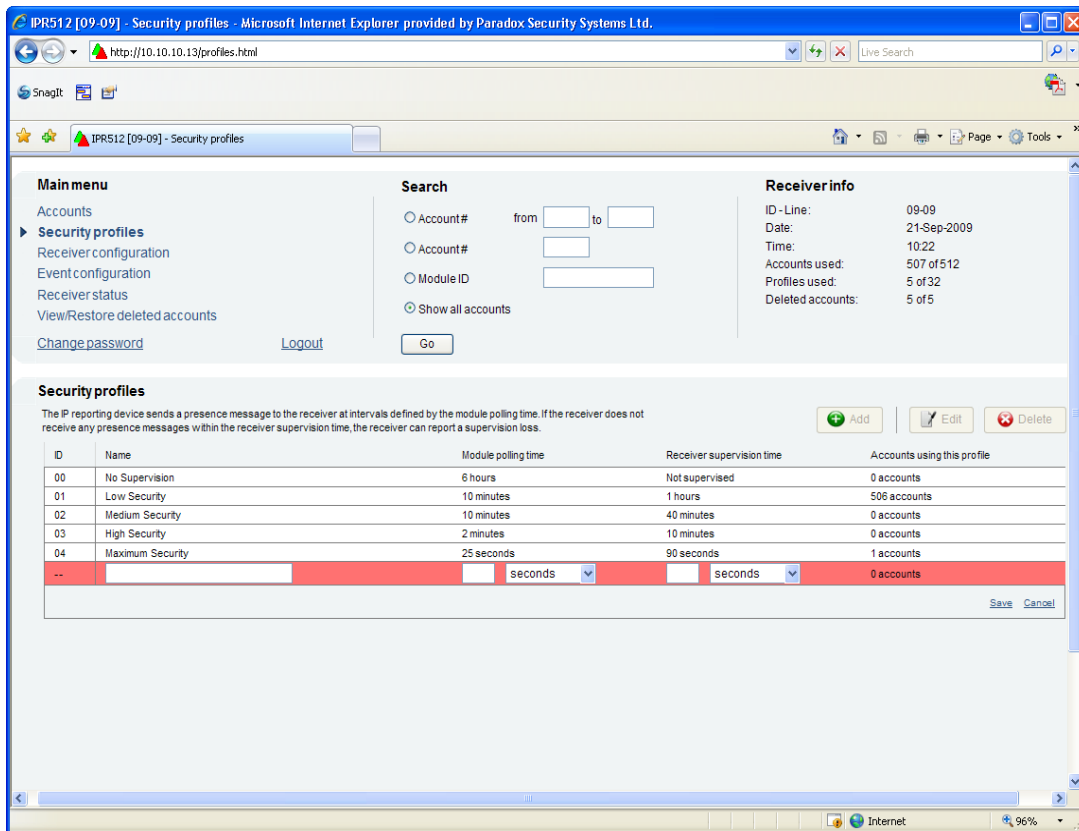

## To Modify an Existing Security Profile

1. Select the Security Profile you wish to modify from the list.
2. Click **Edit**.
3. Click **Save** to save your changes. To cancel any changes without saving, select the **Cancel** option.

**Note:** When a security profile has been modified, all accounts assigned to the security profile will be updated automatically at the next polling time.

**Figure 28: Edit Existing Security Profile**

The screenshot shows a web browser window titled "IPR512 [09-09] - Security profiles - Microsoft Internet Explorer provided by Paradox Security Systems Ltd." The address bar shows "http://10.10.10.13/profiles.html". The page content is divided into several sections:

- Main menu:** Includes links for Accounts, Security profiles (selected), Receiver configuration, Event configuration, Receiver status, View/Restore deleted accounts, Change password, and Logout.
- Search:** Features radio buttons for "Account#" (selected), "Account#" (unselected), and "Module ID" (unselected), with input fields for "from" and "to" values, and a "Go" button.
- Receiver info:** Displays details for the selected receiver: ID-Line: 09-09, Date: 21-Sep-2009, Time: 10:23, Accounts used: 507 of 512, Profiles used: 5 of 32, Deleted accounts: 5 of 5.
- Security profiles:** A table listing various security profiles. Profile 04, "Maximum Security", is highlighted in red and is in an edit state. The table columns are ID, Name, Module polling time, Receiver supervision time, and Accounts using this profile.

ID	Name	Module polling time	Receiver supervision time	Accounts using this profile
00	No Supervision	6 hours	Not supervised	0 accounts
01	Low Security	10 minutes	1 hours	506 accounts
02	Medium Security	10 minutes	40 minutes	0 accounts
03	High Security	2 minutes	10 minutes	0 accounts
04	Maximum Security	25 seconds	90 seconds	1 accounts

## To Delete an Existing Security Profile

1. Select the Security Profile you wish to delete from the list.
2. Click **Delete**.
3. Select **Yes** to delete or **No** to cancel your action.

**Note:** A security profile cannot be deleted if used by one or more accounts. Also, a default security profile cannot be deleted from the system.

**Figure 29: Delete Existing Security Profile**

The screenshot shows a web browser window titled "IPR512 [09-09] - Security profiles - Microsoft Internet Explorer provided by Paradox Security Systems Ltd." The URL is "http://10.10.10.13/profiles.html". The page has a navigation menu on the left with "Security profiles" selected. A search section in the middle allows filtering by account number or module ID. On the right, "Receiver info" shows details for ID-Line: 09-09, Date: 21-Sep-2009, Time: 10:25, Accounts used: 507 of 512, Profiles used: 6 of 32, and Deleted accounts: 5 of 5.

The main content area is titled "Security profiles" and contains a table with the following data:

ID	Name	Receiver supervision time	Accounts using this profile
00	No Supervision		0 accounts
01	Low Security		506 accounts
02	Medium Security		0 accounts
03	High Security		0 accounts
04	Maximum Security	20 seconds	1 accounts
05	Special Supervision	15 minutes / 1 hours	0 accounts

A modal dialog box titled "Question" is overlaid on the table, displaying the message: "Special Supervision will be deleted. Do you want to continue?". It has "Yes" and "No" buttons.

## Receiver Configuration Menu

The Receiver Configuration menu option provides the configuration settings for the IPR512 Receiver. From this menu, you can set WAN and LAN connection settings for communication with the IPR512 Receiver, set COM port settings, language and time zone preferences.

**Figure 30: Receiver Configuration Menu**

The screenshot shows the 'Receiver Configuration' menu for the IPR512 Receiver, accessed via a web browser. The interface is organized into several functional areas:

- Main menu:** Includes links for Accounts, Security profiles, Receiver configuration (selected), Event configuration, Receiver status, View/Restore deleted accounts, Change password, and Logout.
- Search:** Allows searching by Account #, Module ID, or Show all accounts.
- Receiver info:** Displays system details such as ID-Line (09-09), Date (21-Sep-2009), Time (10:27), Accounts used (507 of 512), Profiles used (5 of 32), and Deleted accounts (5 of 5).
- Network Settings (1):** Configures WAN1, WAN2, and LAN interfaces. Each interface has fields for IP address, Netmask, Gateway, DNS primary, and DNS secondary. WAN1 and WAN2 are enabled with ports 18014 and 18015 respectively. LAN is enabled with port 80.
- Output protocol (2):** Configures communication protocols, including Output (Surgard MLR2-DG), Header (00), Trailer (14), Receiver ID (9), Line number (9), and options for ACK/NACK and Test message.
- COM Settings (3):** Configures serial ports COM 1 [PC] and COM 2 [SERIAL OUT] with parameters like Baud rate (19200), Data bits (8), Parity (No), Stop bits (1), and Flow (None).
- Other configuration (4):** Includes Receiver password, Upgrade port (10000), Polling web site (www.google.com), Interval (1-60), and Attempt(s) (1-24). It also features Date and Time settings, including NTP server (pool.ntp.org), Time zone (GMT-05:00 Eastern Time (US & Canada)), and Daylight savings time options.
- Save all changes (5):** A prominent button to save the current configuration.



**Table 11: Receiver Configuration Menu Fields**

Item	Description
<b>1 - WAN1, WAN2, LAN</b>	
Interface enabled	Specifies the type of interface used.
Port	Defines the port number assigned. Port numbers can be between 0 to 65535.
IP address	Defines the IP address assigned to the IPR512 Receiver.
Netmask	Defines the 32-bit mask used to divide an IP address into subnets and specify the network's available hosts.
Gateway	Defines the Gateway address assigned to the network for communication with other computers or networks.
DNS primary	Defines the primary DNS address for translating domain names into IP addresses.
DNS secondary	Defines the secondary DNS address for translating domain names into IP addresses.
<i>Note: Speak to your network administrator to obtain these values.</i>	
<b>2 - Output Protocol</b>	
Output	Displays the reporting format used by the IPR512 Receiver. The IPR512 Receiver is compatible with any automation software that uses the Radionics 6500, Ademco 685, and Sur-Gard MLR2-DG standard. <i>Note: SIA reporting is not supported by the Ademco 685 protocol.</i>
Header	Defines the byte that will be used to signify the beginning of a message. The header values are defined by the output protocol. Values entered can be between 00 - FF. If 00 is set, the header will not be included.
Trailer	Defines the byte that will be used to signify the end of a message. The trailer values are defined by the output protocol. Values entered can be between 01 - FF.
Receiver ID	Defines the unique ID assigned to the IPR512 Receiver. Receiver ID can be between 01 and 99.
Line number	Defines the line number assigned to the IPR512 Receiver. Line numbers can be between 01 - 34.
ACK/NACK protocol	An affirmative or negative response received by the automation software. If this option is enabled, communication with automation software is supervised.
Wait for ACK	Defines the amount of time that the IPR512 GPRS/IP Monitoring Receiver will wait for an acknowledgement from the monitoring station's automation software before sending an "Automation Communication Failure" message.  <i>Note: The system will wait for three attempts before sending the error message.</i>
Test message	Defines whether a presence message is sent at a defined period intervals to ensure communication remains active with automation software.
Every	Defines the interval at which the periodic test message is sent (00 to 99 seconds).
<b>3 - COM Ports</b>	
Baud rate	Defines the data transfer rate from the IPR512 Receiver to the communication link (RS-232).
Data bits	Defines the number of bits used to represent one character of data (most forms of data require eight bits).
Parity	Defines whether parity is being used for error detection.
Stop bits	Defines the number of stop bits used between sending and receiving data.
Flow	Defines the type of flow control used for the serial port COM1 connection.
<b>4 - Other Configuration</b>	
Receiver password	Defines the password used for the registration process of the PCS100/IP100. This password must be entered in the control panel when registering a new PCS100/IP100 to the IPR512 Receiver.
Upgrade port	Defines the port used for system upgrades. This port number must also be provided in the In-Field Paradox Upgrade Software application.
Polling web site	Defines the website address to be polled by the IPR512 Receiver to ensure Internet connection. If no connection is established, a trouble will be set on the LCD, reporting a WAN Internet connection failure.

Item	Description
Interval (1-60)	Defines the interval time the IPR512 will try to connect to the polling web site.
Attempt(s) (1-24)	Defines the number of attempts the IPR512 will try to connect to the polling web site at each interval time set before reporting the "WANx internet connection failure" trouble.
<b>Date and Time</b>	
NTP server	Defines the NTP server used for clock synchronization.
Time Zone	Defines the time zone used at the location of the IPR512 Receiver. It is important to select the proper time zone to ensure date and times are properly reflected in the IPR512 Receiver Account Management System.
Manual	Defines whether date and time information will be configured manually. If configuring the date and time manually, define the month (MM), day (DD), year (YYYY), and time HH:MM (24-hour time format) to ensure that date and times are properly reflected in the IPR512 Receiver Account Management System.
Daylight savings time	<p>Defines when the daylight saving time occurs.</p> <p><b>To Configure Daylight Savings Time</b></p> <ol style="list-style-type: none"> <li>1. Define the start date of DST (Day: DD and Month: MM).</li> <li>2. Define the end date of DST Day: DD and Month: MM).</li> <li>3. Define the day of the week that DST occurs (Monday - Sunday). DST will occur the day of the week defined after the start date set in Step 1.</li> <li>4. Define the time of day that DST occurs (HH:MM).</li> </ol> <p><b>Note:</b> Although the date is different each year, you only need to set the start and end date and times once for DST to take effect.</p>
<b>5 - Save all changes</b>	
Save	Updates and saves all the changes implemented in the Receiver Configuration menu.

## Event Configuration Menu

The Event Configuration menu option allows you to configure the event codes that will be sent to the monitoring station's automation software. The IPR512 Account Management System supports account related events and IPR512 receiver events. From this menu, you can define the type of event to report and set the reporting format (CID and SIA).

**Figure 31: Event Configuration Menu**

The screenshot shows the 'Event Configuration Menu' in a web browser. The browser title is 'IPR512 [09-09] - Events - Microsoft Internet Explorer provided by Paradox Security Systems Ltd.'. The address bar shows 'http://10.10.10.13/event.html'. The page content is organized into several sections:

- Main menu:** Includes links for Accounts, Security profiles, Receiver configuration, **Event configuration** (selected), Receiver status, and View/Restore deleted accounts. There are also links for 'Change password' and 'Logout'.
- Search:** Features search filters for Account # (with 'from' and 'to' fields), Module ID, and a 'Show all accounts' option. A 'Go' button is present.
- Receiver info:** Displays details for ID - Line (09-09), Date (21-Sep-2009), Time (10:35), Accounts used (507 of 512), Profiles used (5 of 32), and Deleted accounts (5 of 5).
- Account events:** Contains a table with columns for Events description, Reported, CID, and SIA. An 'Edit' button is located to the right of the table.
- Receiver events:** Includes 'Receiver settings' with an 'Account #' field (value: 9999) and 'Reporting format' options (CID is selected, SIA is unselected). A 'Save' button is next to the settings. Below this is another table with columns for Event description, Reported, and Report CID. An 'Edit' button is also present here.

The browser status bar at the bottom shows 'Done', 'Internet', and a zoom level of 76%.

## Account Events

The following account events are pre-set in the system:

- **Account supervision loss** - sends a message to the monitoring station's automation software when communication is lost at the site, for more information, please refer to "Security Profiles Menu" on page 28.
- **Account supervision restore** - sends a message to the monitoring station's automation software when communication has been restored at the site, for more information, please refer to the "Security Profiles Menu" on page 28.
- **Account registration** - sends a message to the monitoring station's automation software when an account has been registered.
- **Account deleted** - sends a message to the monitoring station's automation software when an account has been deleted, for more information, please refer to the "View/Restore Deleted Accounts Menu" on page 41

### To Enable and Modify an Account Event

1. Select the Event you wish to modify from the list.
2. Click **Edit**.
3. Select whether the event code will be reported. To not report an event, uncheck the **Reported** check box.
4. Modify the Event code.
5. Click **Save** to save your changes. To cancel any changes without saving, click **Cancel**.

**Figure 32: Edit Existing Account Event**

Events description	Reported	CID	SIA
Account supervision loss	<input checked="" type="checkbox"/>	700	zz
Account supervision restore	<input type="checkbox"/>		
Account registration			
Account deleted			

**Table 12: Account Event Fields**

Item	Description
Event description	Provides a description of the event.
Reported	Defines whether the IPR512 Receiver will report special events to the monitoring station's automation software.
CID	Defines the reporting code assigned to the event. This code will be sent the to monitoring station's automation software. The CID event code is a 3-digits code.
SIA	Defines the reporting code assigned to the event. This code will be sent the to monitoring station's automation software. The SIA event code is a 2-letter code.

## Receiver Events

The following receiver account events are pre-set in the system. The receiver events are sent to the monitoring station's automation software and to the serial output.

- **Memory card error** - sends a message to the monitoring station's automation software when the memory card could not be detected, written to or cannot be initialized.
- **Memory card restore** - sends a message to the monitoring station's automation software when "memory card not present" or "memory card error" has been resolved.
- **Backup restore from memory card** - sends a message to the monitoring station's automation software when a backup has been restored from the memory card.
- **IPR512 power up** - sends a message to the monitoring station's automation software when the IPR512 Receiver has been powered up.
- **Automation software communication failure** - sends a message to the monitoring station's automation software and to the serial output port when communication with the automation software could not be established.
- **Automation software communication restore** - sends a message to the monitoring station's automation software and to the serial output port when communication with the automation software has been restored.
- **Account database reached 75%** - sends a message to the monitoring station's automation software when the account database account capacity has reached 75%.
- **Account database reached 100%** - sends a message to the monitoring station's automation software when the account database account capacity has reached 100%.
- **Account cannot register, database is full** - sends a message to the monitoring station's automation software when an attempt to register has been done on a full database.
- **Web login** - sends a message to the monitoring station's automation software when a successful login attempt has been made via the IPR512 Account Management System.
- **NTP server failure** - sends a message to the monitoring station's automation software when communication to the NTP server cannot be established.
- **NTP server restore** - sends a message to the monitoring station's automation software when communication to the NTP server is restored.
- **LAN network connection failure** -sends a message to the monitoring station's automation software when communication failure has occurred on the LAN.
- **LAN network connection restore** -sends a message to the monitoring station's automation software when communication on the LAN has been restored.
- **WAN1 network connection failure** - sends a message to the monitoring station's automation software when a network failure has occurred.
- **WAN1 network connection restore** - sends a message to the monitoring station's automation software when the network connection has been restored.
- **WAN1 internet connection failure** - sends a message to the monitoring station's automation software when communication to the internet (to the polling website defined in the Receiver Configuration menu) via WAN1 cannot be established.
- **WAN1 internet connection restore** - sends a message to the monitoring station's automation software when communication to the internet (to the polling website defined in the Receiver Configuration menu) via WAN1 has been restored.
- **WAN2 network connection failure** - sends a message to the monitoring station's automation software when a network failure has occurred.

- **WAN2 network connection restore** - sends a message to the monitoring station's automation software when the network connection has been restored.
- **WAN2 internet connection failure** - sends a message to the monitoring station's automation software when communication to the internet (to the polling website defined in the Receiver Configuration menu) via WAN2 cannot be established.
- **WAN2 internet connection restore** - sends a message to the monitoring station's automation software when communication to the internet (to the polling website defined in the Receiver Configuration menu) via WAN2 has been restored.

### To Enable and Modify an Receiver Event

1. Enter the IPR512 Receiver's account number in the account # box.
2. Select the reporting format (CID or SIA).
3. Click **Save**.
4. Select the Event you wish to modify from the list.
5. Click **Edit**.
6. Select whether the event code will be reported. To not report an event, uncheck the Reported check box.
7. Enter or modify the Event code.
8. Click **Save** to save your changes. To cancel any changes without saving, click **Cancel**.

**Figure 33: Edit Existing Receiver Events**



**Table 13: Receiver Event Fields**

Item	Description
Account #	Defines the IPR512 Receiver's account number. When a receiver event is sent to the monitoring station's automation software, the account number is sent as well in order to track which receiver is reporting the event.
Reporting format	Defines the reporting format used by the IPR512 Receiver.
CID	Select for CID reporting (3-digit code). <b>Note:</b> When defining certain CID events*, if a new event and restore event have the same CID code, the IPR512 will use the CID restore identifier when sending the event to the automation software.
SIA	Select for SIA reporting (2-letter code).
Save	Updates and save current changes.
Event description	Provides a description of the event.
Reported	Defines whether the IPR512 Receiver will report special events to the monitoring station's automation software and serial output.
Report code	Defines the code assigned to the special event. This code will be sent the to monitoring station's automation software. Event codes can be either in SIA (2-letters) or CID format (3-digits).
* List of events that support this feature include: Account Events - Account supervision loss/restore Receiver Events - Automation software communication failure/restore LAN network connection failure/restore Memory card error/restore NTP server failure/restore WAN1 internet connection failure/restore WAN1 network connection failure/restore WAN2 internet connection failure/restore WAN2 network connection failure/restore	

## Receiver Status Menu

The Receiver Status menu option displays a listing of all the IPR512 Receiver's troubles that are occurring on the system and lists the IPR512 Receiver's system information. Troubles can be viewed in the IPR512 Receiver Account Management System or directly from the IPR512 Receiver's LCD screen, by entering the troubles menu. For more information on viewing receiver troubles using the LCD screen, refer to "Troubleshooting and Maintenance" on page 46.

There are two states that the IPR512 Receiver can report, they include:

Status Icon	Description
	Receiver status is normal.
	Receiver is experiencing troubles.

**Note:** If troubles are occurring on the system, clicking on the Trouble icon in the Receiver Info section at the top of the IPR512 Receiver Account Management System screen will bring you directly to the Receiver Status menu.

**Figure 34: Receiver Status Menu**

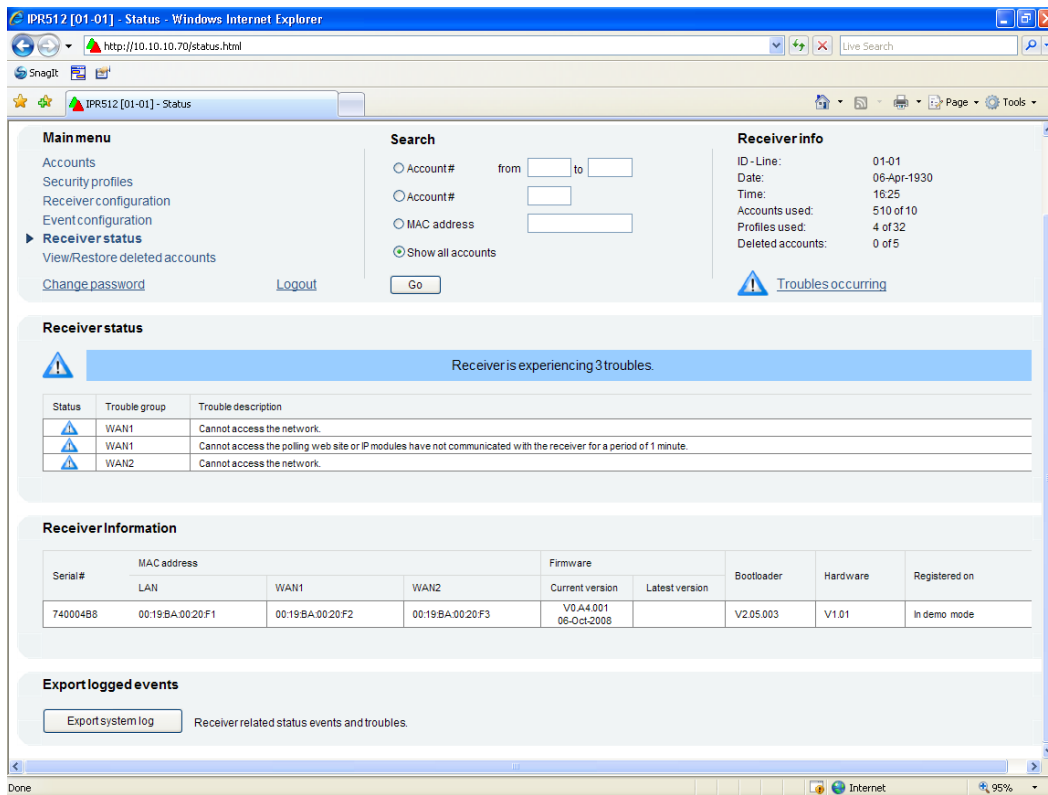

**Table 14: Receiver Status Fields**

Item	Description
Status	Displays the status of the IPR512 Receiver.
Trouble group	Displays the origin of the trouble. Trouble groups include WAN1, WAN2, LAN, serial, and memory
Trouble description	Displays a description of the trouble that is occurring on the IPR512 Receiver.

The following describes the possible trouble descriptions:

- **WAN1** - Programmed attempts to access polling web site failed.
- **WAN2** - Programmed attempts to access polling web site failed.
- **LAN** - Cannot communicate with the network.
- **Serial** - Cannot communicate with the automation software.
- **Memory** - Card not detected or memory card error.

**Table 15: Receiver Information Fields**

Item	Description
Serial #	Displays the serial number of the IPR512 Receiver.
MAC address - LAN	Displays the MAC address assigned to the LAN.
MAC address - WAN1	Displays the MAC address assigned to the WAN1.
MAC address - WAN2	Displays the MAC address assigned to the WAN2.
Firmware Current Version	Displays the firmware version that installed in the IPR512 Receiver.
Firmware Latest Version	Displays the most current version of firmware available. If the most recent is installed on the receiver, then the latest version will not be displayed.
Bootloader	Displays the bootloader version installed on the IPR512 Receiver.
Hardware	Displays the hardware version of the IPR512 Receiver.
Registered on	Displays the date the IPR512 Receiver was registered.

The IPR512 Receiver Account Management System stores a log file that tracks system events and troubles that have occurred on the IPR512 Receiver. It is an XML document that keeps track of the most recent events that have occurred in the system (150 events buffered). The system log file is used for troubleshooting purposes only.

### To Export the System Log File

1. Select the **Export Logged Events** button.
2. Select **Save** to save the IPR251\_XX(receiver ID)\_XX (line ID)\_systemlog.xls or select **Open** to open the file.
3. If you have selected the open option, a File Download dialog box will be displayed. Select the preferred method of opening the file and click **OK**, select **Cancel**, to cancel this operation.

**Figure 35: Export Logged Events**

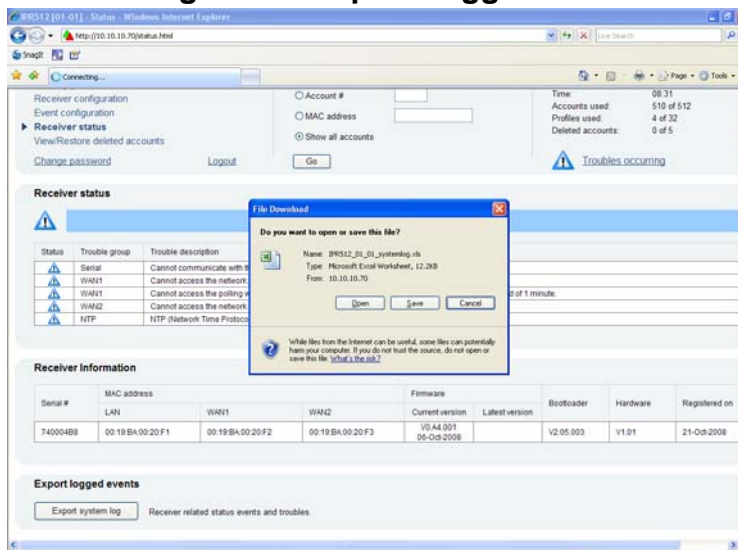



## View/Restore Deleted Accounts Menu

The View/Restore Deleted Accounts menu acts as a safety net when deleting accounts from the system. When you delete an account, the IPR512 Account Management System places these files in a temporary storage place thus allowing you to decide whether or not to permanently delete the accounts from your system. Once you delete the files from the View/Restore Deleted Account menu, the accounts cannot be restored.

**Note:** Once an account has been sent to into temporary storage (temporarily removed from the system until deleted), the account will no longer be polled.

**Figure 36: View/Restore Deleted Accounts Menu**

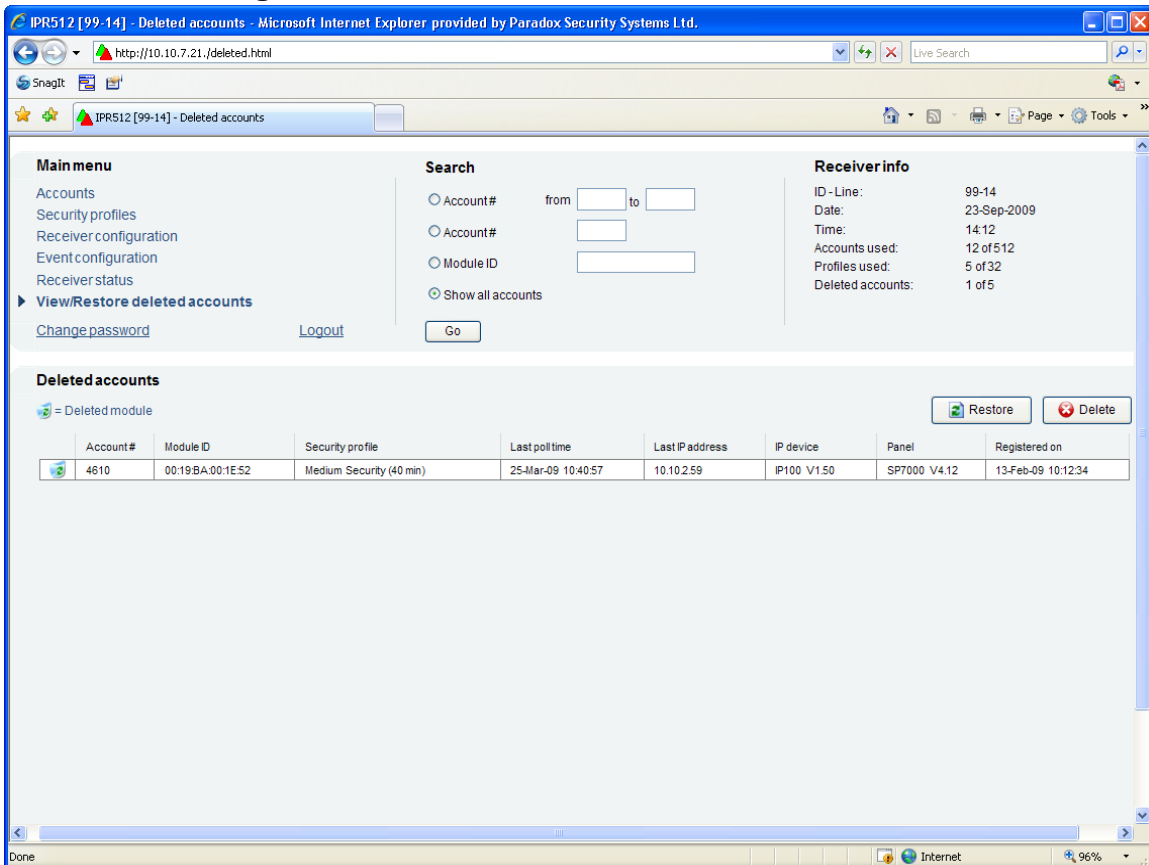

**Table 16: Deleted Accounts Fields**

Item	Description
Status icon	Displays the recycle bin icon for deleted accounts.
Account #	Displays the account number assigned to the current account.
MAC address	Displays the MAC address or unique ID assigned to the Paradox reporting module.
Security profile	Displays the security profile assigned to the current account. For more information on setting the Security profile values, refer to "Security Profiles Menu" on page 28.
Last poll time	Displays the last date and time that the account's IP device sent a presence message to the IPR512 Receiver at the configured Module Polling Time. For more information on setting the Security profile values, refer to "Security Profiles Menu" on page 28.
Last IP address	Displays the IP address of the last IP device that sent a message to the IPR512 Receiver.
IP device	Displays the internet module used at the account site.
Panel	Displays the panel type used at the account site.
Registered on	Displays the time and date of when the module was registered.

## To Restore a Deleted Account

1. Select the account you wish to restore from the list.
2. Click on **Restore**.
3. Select **Yes** to delete or **No** to cancel your action.

**Figure 37: Restore Deleted Account**

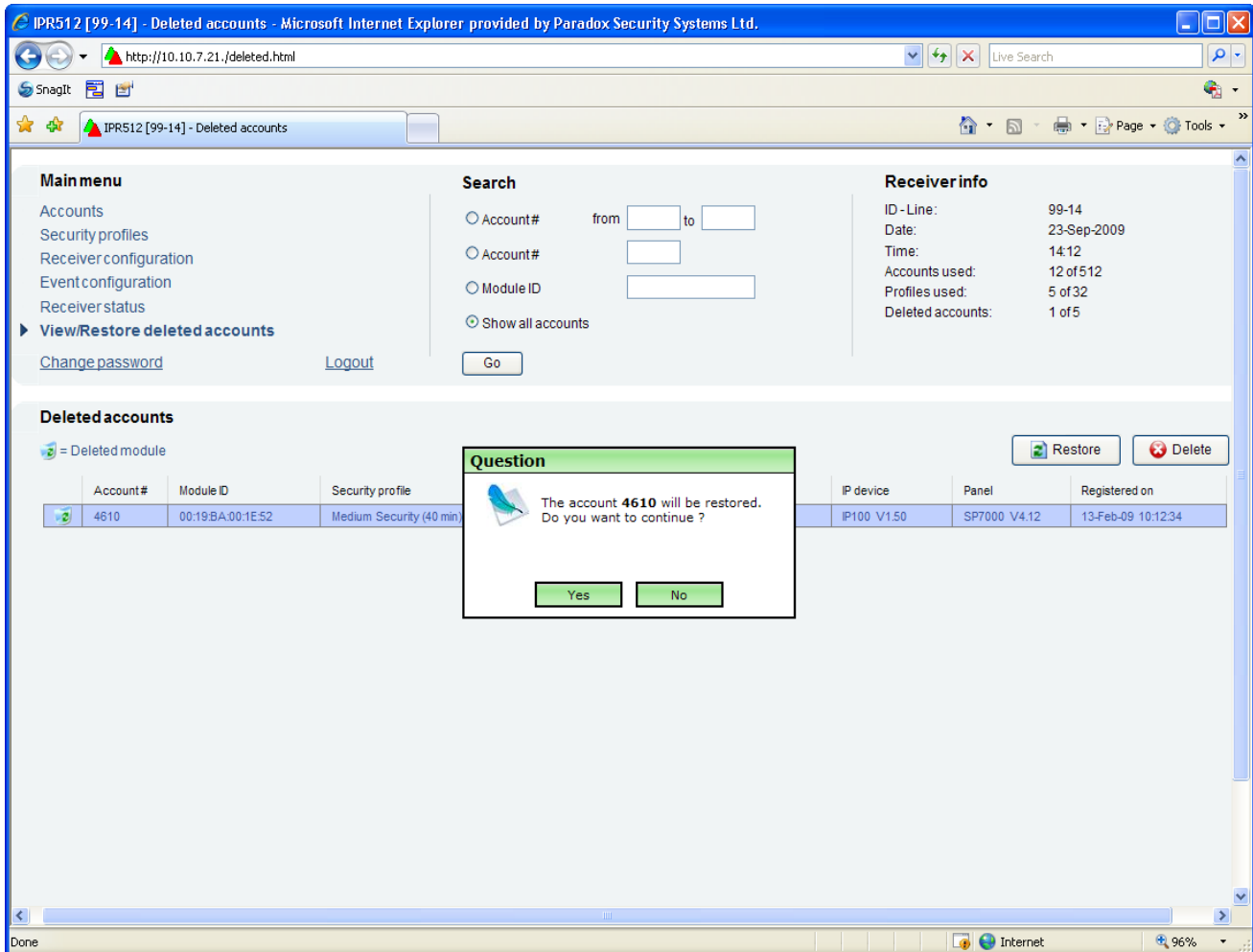

## To Permanently Delete a Deleted Account

1. Select the account you wish to delete from the list.
2. Click on **Delete**.
3. Select **Yes** to delete or **No** to cancel your action.

**Figure 38: Permanently Delete a Deleted Account**

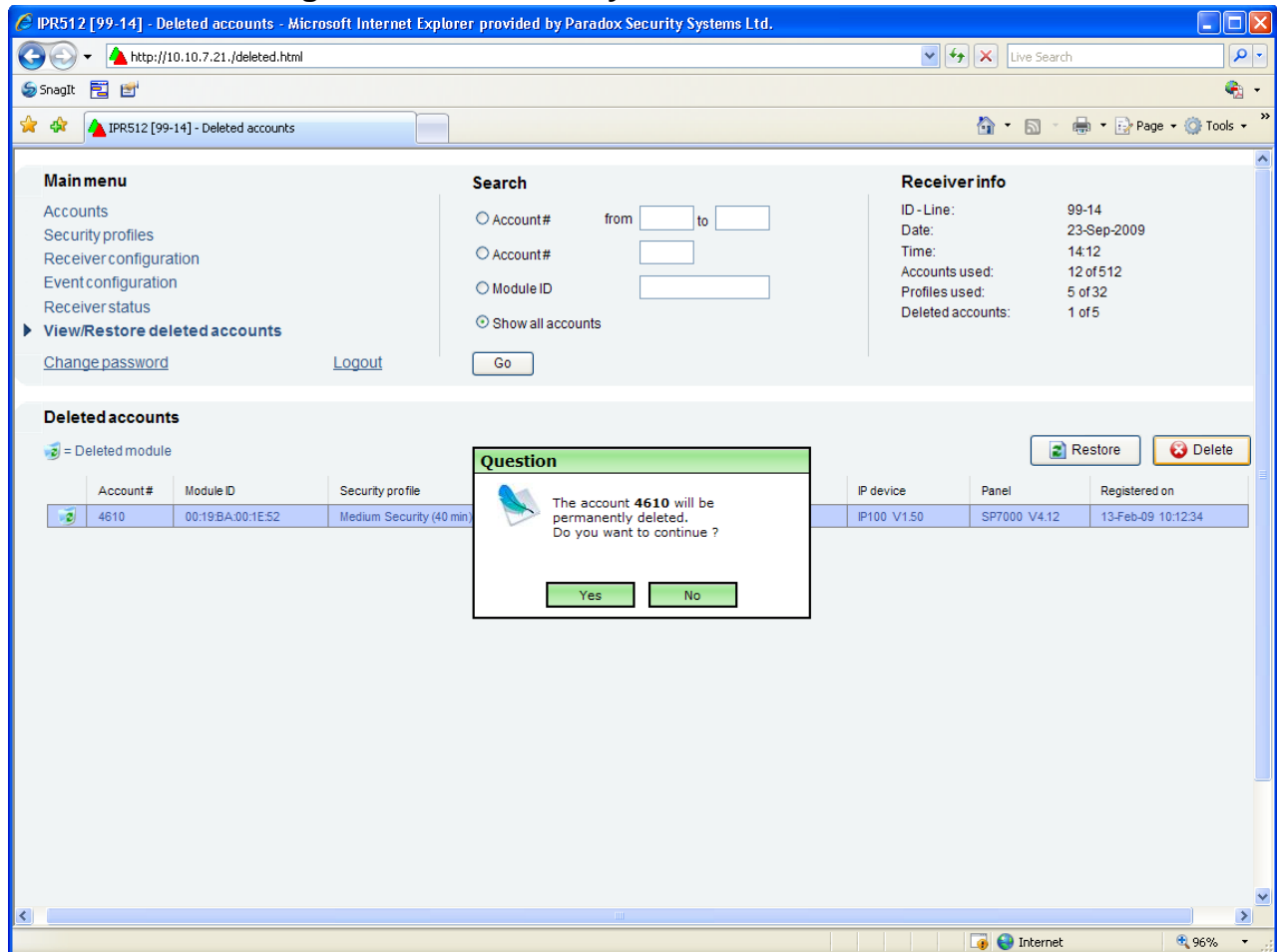

## Chapter 6: IPR512 Receiver LCD System Configuration

This chapter guides you through the steps required to configure the IPR512 Receiver using the LCD display and Keypad Interface located on IPR512 Receiver. These steps can be used if you are experiencing difficulties with the IPR512 Account Management System. For more information on how to configure the IPR512 Receiver using the IPR512 Account Management System, refer to “System Configuration” on page 18. The backlight and contrast settings are also described.

**Note:** Some of the menu options are password protected. Enter the password that is used when logging into the IPR512 Receiver Account Management System. The default password is set to admin.

### Setting the IP Address, Port and Subnet Mask

By default, the IPR512 Receiver is configured with a default IP address, port and subnet mask. For more information on the IPR512 Receiver’s system defaults, refer to “IPR512 Receiver System Defaults” on page 8. The default settings can be re-configured if communication cannot be established with your network. The defaults can be configured through the IPR512 Receiver’s LCD menu.

#### To Configure the IPR512 Receiver IP Address, Port and Subnet Mask

1. Press **OK** to access the Main Menu on the IPR512 Receiver. If there are any troubles, pressing OK will enter the Trouble Menu. If this occurs, press **X** to access the Main Menu.
2. Use the Up/Down arrows and scroll to “LAN settings” and press **OK**.
3. Enter your password. Use the Up and Down arrows to change the value, use the Left and Right arrows to scroll. Press **OK** when done.
4. The LCD will display “LAN IP Addr/Port” and “LAN Subnet mask” menu, use the Up and Down arrows to change the value, use the Left and Right arrows to scroll. Press **OK** when done.
5. Change the Port and press **OK** when done. The port must be a five digit value, therefore when providing a port number of i.e. 80, it must be entered as 00080.
6. Use the Up and Down arrows to change the LAN Subnet Mask and use the Left/Right arrows to scroll. Press **OK** when done.

The LCD screen will display “New LAN Settings saved”.

**Figure 39: IPR512 Receiver LAN, IP and Port Settings**

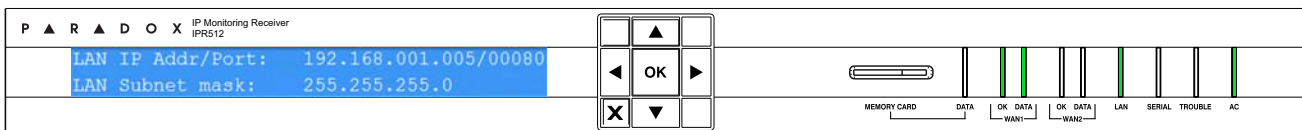

The backlight and the contrast levels can also be configured directly on the IPR512 Receiver. The following section describes these settings.

### To Set the Contrast

1. Press **OK** to access the Main Menu on the IPR512 Receiver. If there are any troubles, pressing **OK** will enter the Trouble Menu. If this occurs, press **X** to access the Main Menu.
2. Use the Up/Down arrows and scroll to "LCD settings" and press **OK**.
3. Use the Up/Down arrows and scroll to "Set Contrast". The LCD will display the selected menu item.
4. Use the Left and Right arrows to change the value and press **OK** when done. Press **X** to quit without saving.

**Figure 40: IPR512 Receiver Contrast Setting**

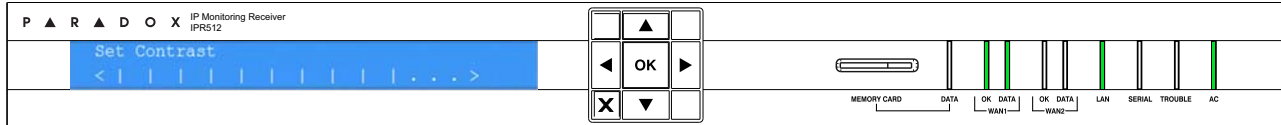

### To Set the Backlight

1. Press **OK** to access the Main Menu on the IPR512 Receiver. If there are any troubles, pressing **OK** will enter the Trouble Menu. If this occurs, press **X** to access the Main Menu.
2. Use the Up/Down arrows and scroll to "LCD settings" and press **OK**.
3. Use the Up/Down arrows and scroll to "Set backlight". The LCD will display the selected menu item.
4. Use the Left and Right arrows to change the value and press **OK** when done. Press **X** to quit without saving.

**Figure 41: IPR512 Receiver Backlight Setting**

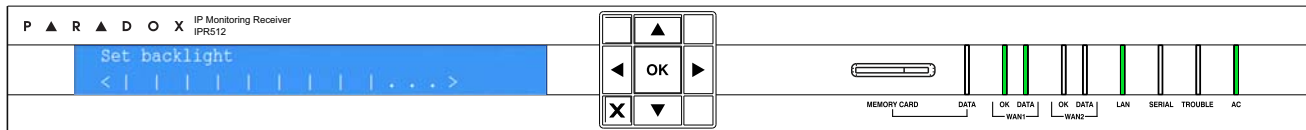

# Chapter 7: Troubleshooting and Maintenance

This chapter provides a listing of the troubles that may be present on the IPR512 Receiver. System backup procedures and firmware upgrades are also described.

## Troubles Overview

The IPR512 Receiver provides several LED status indicators to indicate if any critical errors have occurred. If a trouble occurs on the IPR512 Receiver, the Trouble LED will turn on. The LCD screen will then display a message indicating the number of troubles that have occurred. When all the troubles have been resolved, the Trouble LED will then turn off. Refer to “LCD Menu” on page 47 for a listing of the different types of troubles that may occur on the IPR512 Receiver. Refer to LED Status Indicators for a description of the LEDs.

### To View Troubles

1. Press **OK** to enter the Trouble Menu.
2. Use the Up and Down arrows to scroll and view messages. The LCD will display the trouble that has occurred.
3. Press **OK** when done.

**Figure 42: Viewing Troubles**

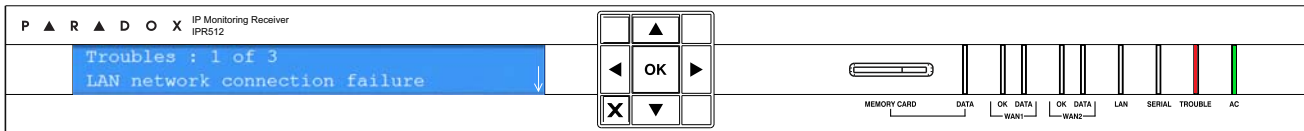
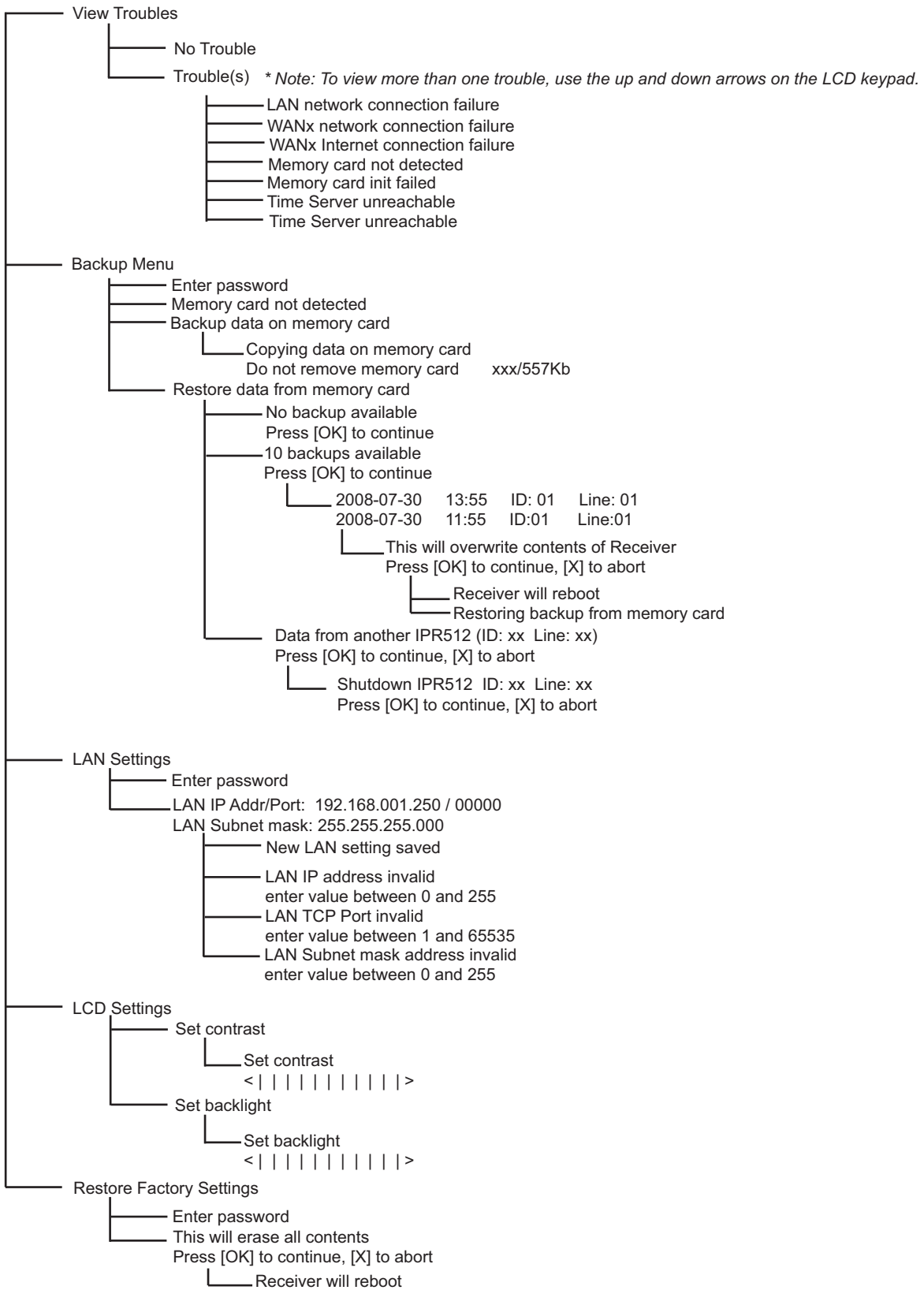

**Table 17: LED Status Indicators**

LED	Color	Description
Data	Green Off	Memory card is being accessed. Memory card not in use.
WAN1		
OK	Green Off	Network connection is detected on WAN1 port. IPR512 Receiver cannot access the network.
Data	Green Off	Sending or receiving data through WAN1 port. IPR512 Receiver cannot access the polling web site or IP modules are not communicating with the receiver for a period of 1 minute.
WAN2		
OK	Green Off	Network connection is detected on WAN2 port. IPR512 Receiver cannot access the network.
Data	Green Off	Sending or receiving data through WAN2 port. IPR512 Receiver cannot access the polling web site or IP modules are not communicating with the receiver for a period of 1 minute.
LAN	Green Off	Sending or receiving data through LAN port. Not communicating with the network.
Serial	Green Off	Connection is established with the automation software. IPR512 Receiver is not communicating with the automation software or ACK/NACK is not enabled.
Troubles	Red	Trouble is detected on the IPR512 Receiver. Troubles can be viewed through the LCD screen.
AC	Green Off	Power is present. No power detected.

**Figure 43: LCD Menu**

LCD Menu



## System Backup Overview

The IPR512 Receiver provides up to 10 data backups to the memory card which are automatically performed 10 minutes after a change has been made in the database or on demand (manually) through the LCD and 6-Button Keypad Interface. Stored data includes the receiver's configuration settings and all system account information. The last ten backups are kept on the memory card. If the IPR512 Receiver experiences a crash, fast and easy substitution of memory cards from one receiver to another provides practically no down time for recovery situations.

### To Conduct a System Backup

1. Press **OK** on the IPR512 Receiver to access the Main Menu. If there are any troubles, pressing OK will enter the Trouble Menu. If this occurs, press **X** to access the Main Menu.
2. Use the Up/Down arrows and scroll to "Backup menu" and press **OK**.
3. Enter your password. Use the Up and Down arrows to change the value, use the Left and Right arrows to scroll. Press **OK** when done.
4. Select "Backup data on memory card" and press **OK**. The IPR512 Receiver will then begin copying data on the memory card.



**Do not remove the Memory Card from the Memory Card Slot until backup is complete.**

**Figure 44: IPR512 Receiver System Backup**

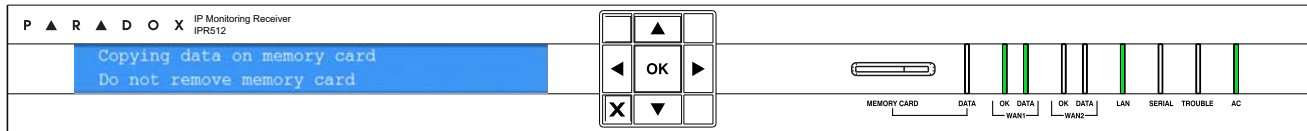

### To Conduct a Restore from a Backup

1. Press **OK** on the IPR512 Receiver to access the Main Menu. If there are any troubles, pressing OK will enter the Trouble Menu. If this occurs, press **X** to access the Main Menu.
2. Use the Up/Down arrows and scroll to "Backup menu" and press **OK**.
3. Enter your password. Use the Up and Down arrows to change the value, use the Left and Right arrows to scroll. Press **OK** when done.
4. Select "Restore data from memory card" and press **OK**. The IPR512 Receiver will then display the backups that are currently available.
5. Select the appropriate backup by using the Up and Down arrow keys, press **OK** to accept. The IPR512 Receiver will display message "This will overwrite contents of IPR512". Press **OK** to accept and the receiver will reboot or press **X** to cancel this procedure.

**Figure 45: IPR512 Receiver Restore from Backup**

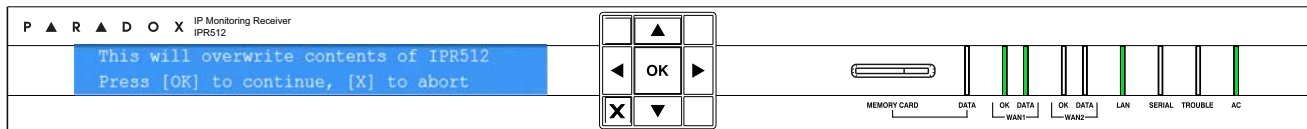



## To Restore Backup from another IPR512 Receiver

1. Remove the memory card from the problematic IPR512 Receiver.
2. Insert the memory card into the Memory Card Slot of the new IPR512 Receiver.
3. Press **OK** on the receiver to access the Main Menu. If there are any troubles, pressing OK will enter the Trouble Menu. If this occurs, press **X** to access the Main Menu.
4. Use the Up/Down arrows and scroll to “Backup menu” and press **OK**.
5. Enter your password. Use the Up and Down arrows to change the value, use the Left and Right arrows to scroll. Press **OK** when done.
6. Use the Up/Down arrows and scroll to “Restore data from memory card”. The LCD will display the selected menu item. At this point the IPR512 Receiver will prompt you that there is data from another IPR512 (ID: XX Line: XX).
7. Select **OK** to overwrite contents currently on the system or **X** to cancel the procedure. If you select **OK** the receiver will reboot and copying of data will begin.
8. Select **OK** to shutdown the receiver or **X** to cancel. If you select OK, the receiver will then copy data and then reboot.



**Do not remove the Memory Card from the Memory Card Slot until backup is complete.**

**Figure 46: IPR512 Receiver Restore**

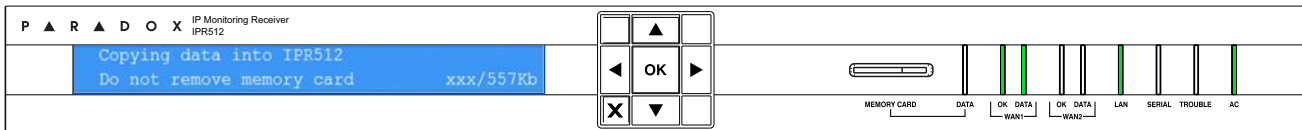

## Firmware Upgrade Overview

The IPR512 Receiver's firmware\* can be upgraded using the In-Field Paradox Upgrade Software application. From this application, you can specify the IPR512 Receiver or IP Module to upgrade and which software version to install. When you confirm the update, the IPR512 Receiver or IP Module will be upgraded with the newest update and will be up and running in less than 90 seconds.

\*Automatic firmware upgrade not supported by current version. Please check the web for updates.

### Accessing the In-Field Paradox Upgrade Software Application

In order to access the In-Field Paradox Upgrade Software Application, the application must first be installed on your hard drive. The In-Field Paradox Upgrade Software Application can also be downloaded from the Paradox website at [www.paradox.com](http://www.paradox.com).

#### To Access the In-Field Paradox Upgrade Software Application

1. Locate the InField.exe file on your PC or double-click the In-Field icon from your desktop.
2. If the icon is not on your desktop, double-click on the executable file to launch the In-Field Paradox Upgrade Software application.

When the application is launched, the Main screen is then displayed, as shown in In-Field Paradox Upgrade Software Application.

**Figure 47: In-Field Paradox Upgrade Software Application**

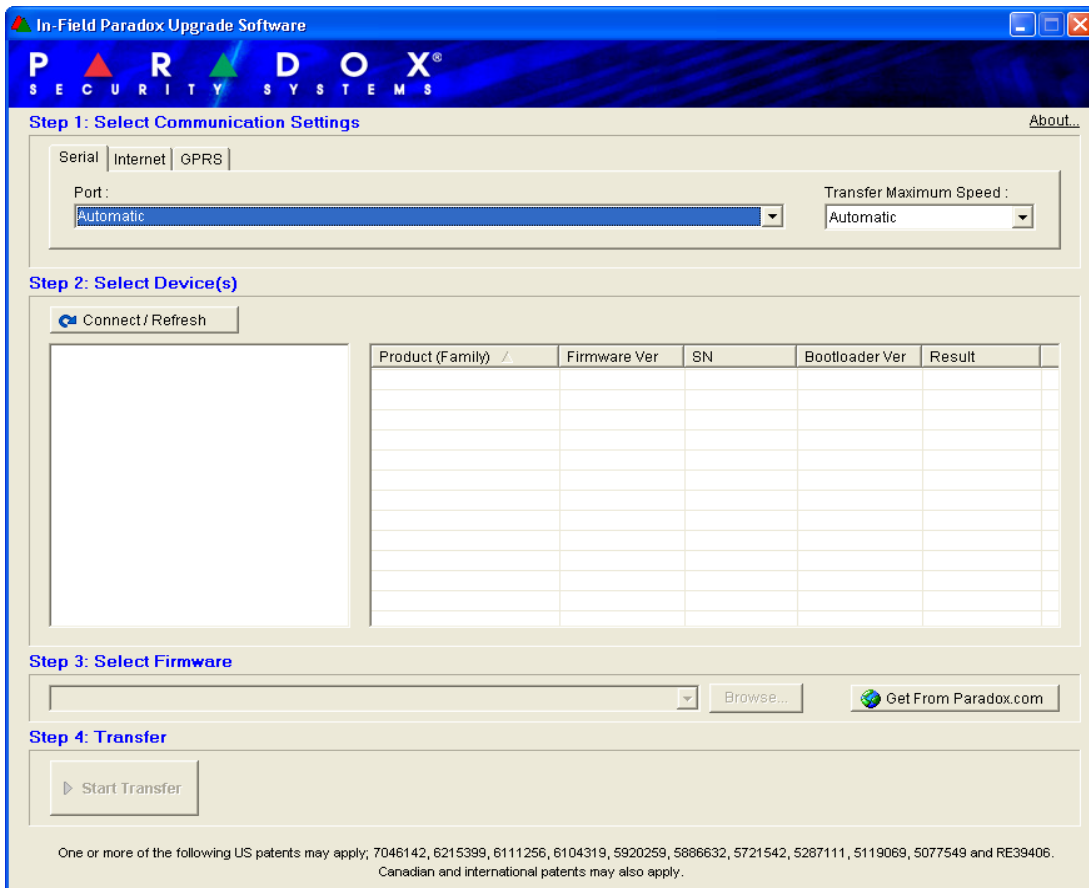

## To Upgrade Firmware using a Serial Connection

Before beginning the upgrade process, ensure that the serial cable is connected between the COM2 Port of the IPR512 Receiver and your PC. Ensure that the **Serial** Tab is selected from the In-Field Paradox Upgrade Software window.

### Step 1: Define Communication Settings

1. Select the communication port to be used from the Port drop-down list.
2. Select the transfer speed from the Transfer Maximum Speed drop-down list (automatic is recommended).
3. Proceed to Step 2.

**Figure 48: Communication Settings**

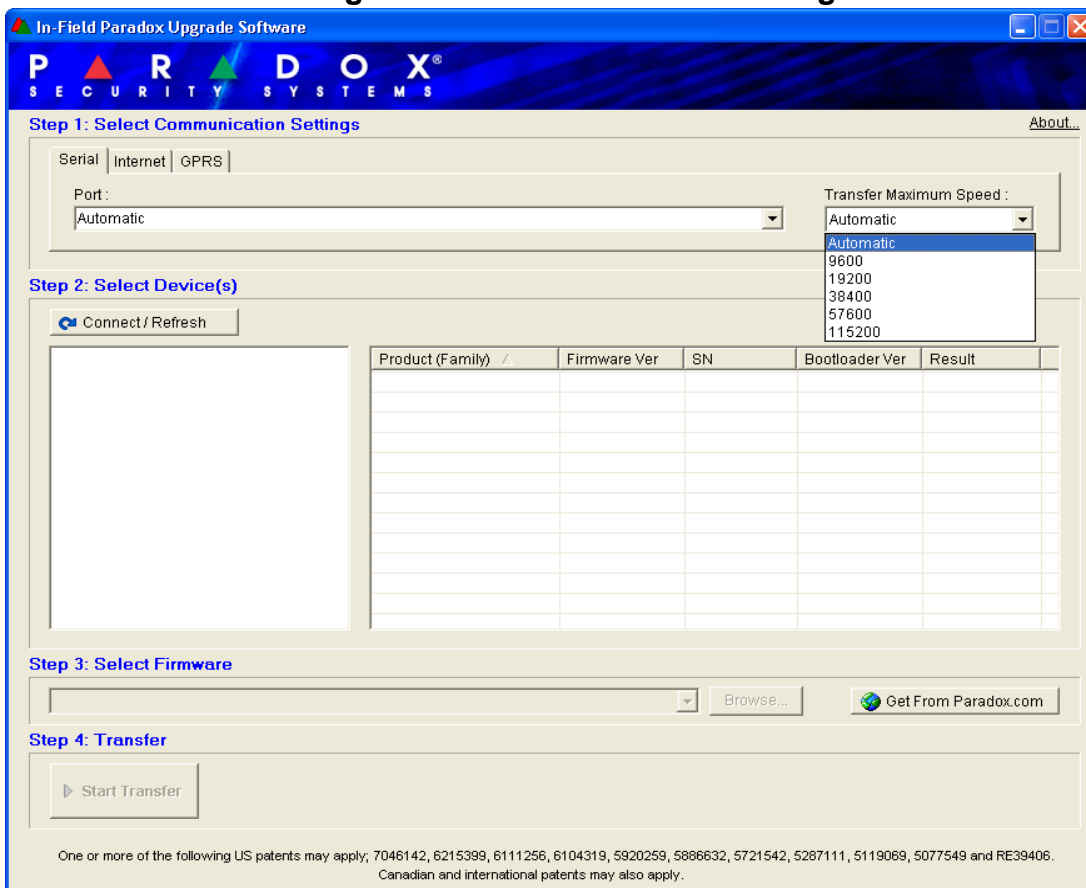

## Step 2: Select Devices

1. Press the **Connect/Refresh** button. A Progress dialog box will appear. The progress dialog box detects the connection to the port.
2. Select the Product to update from the list.
3. Proceed to Step 3.

**Note:** When conducting a firmware upgrade through a serial connection, you can only upgrade the IPR512 Receiver to which you are currently connected to.

**Figure 49: Select Devices**

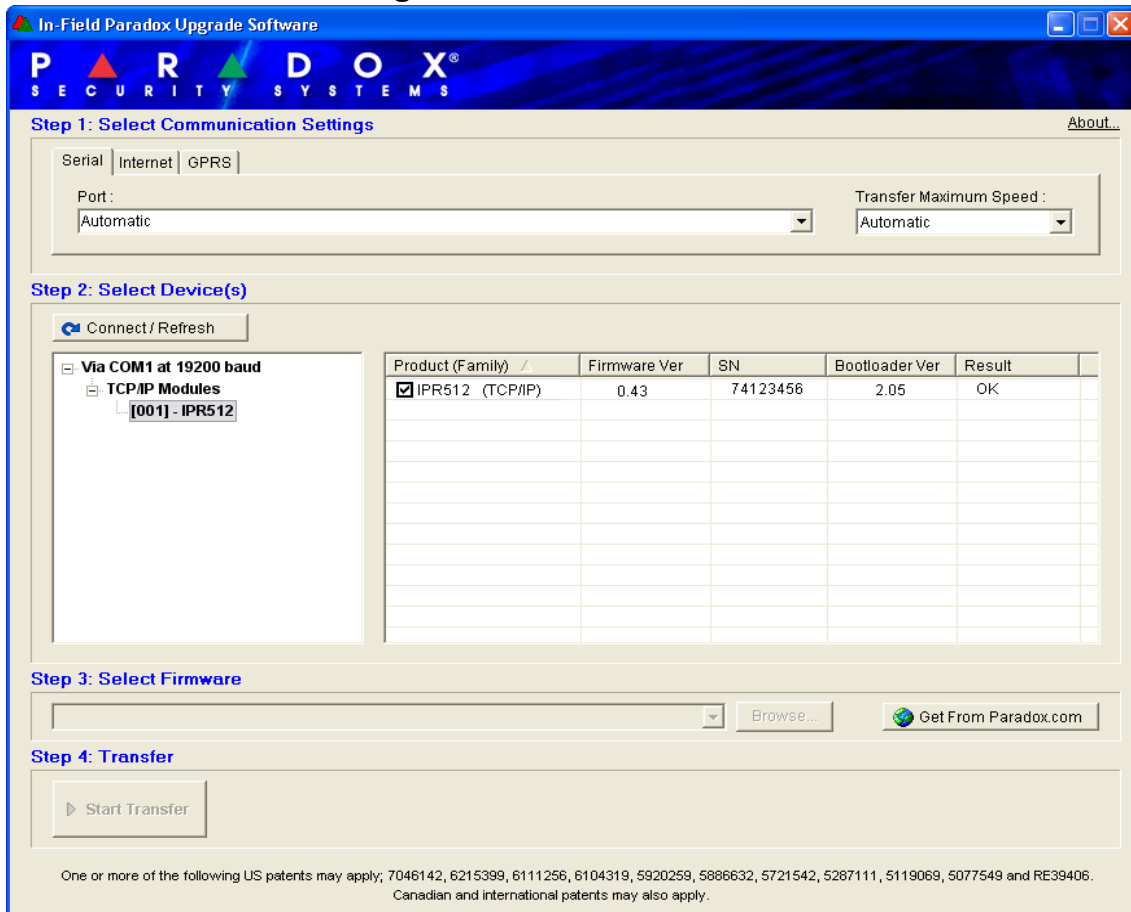

### Step 3: Select Firmware

1. Select the firmware version from the list. If the firmware version displayed in the Select Firmware window is the most recent, proceed to Step 4.
2. Press **Browse** to locate a file in another location (upgrade files have a “.puf” extension).
3. Select the file from the Browse window. When the file is selected, it will be displayed in the Select Firmware window. You can also click on **Get from Paradox.com** to download the latest firmware upgrade files directly from the Paradox website.
4. Proceed to Step 4.

**Note:** If you select a version that is older than the one currently installed on the IPR512 Receiver, the system will display a warning stating that you are about to transfer an older firmware version. If you want to proceed, confirm the message, if you wish to cancel then do so.

**Figure 50: Firmware Selection**

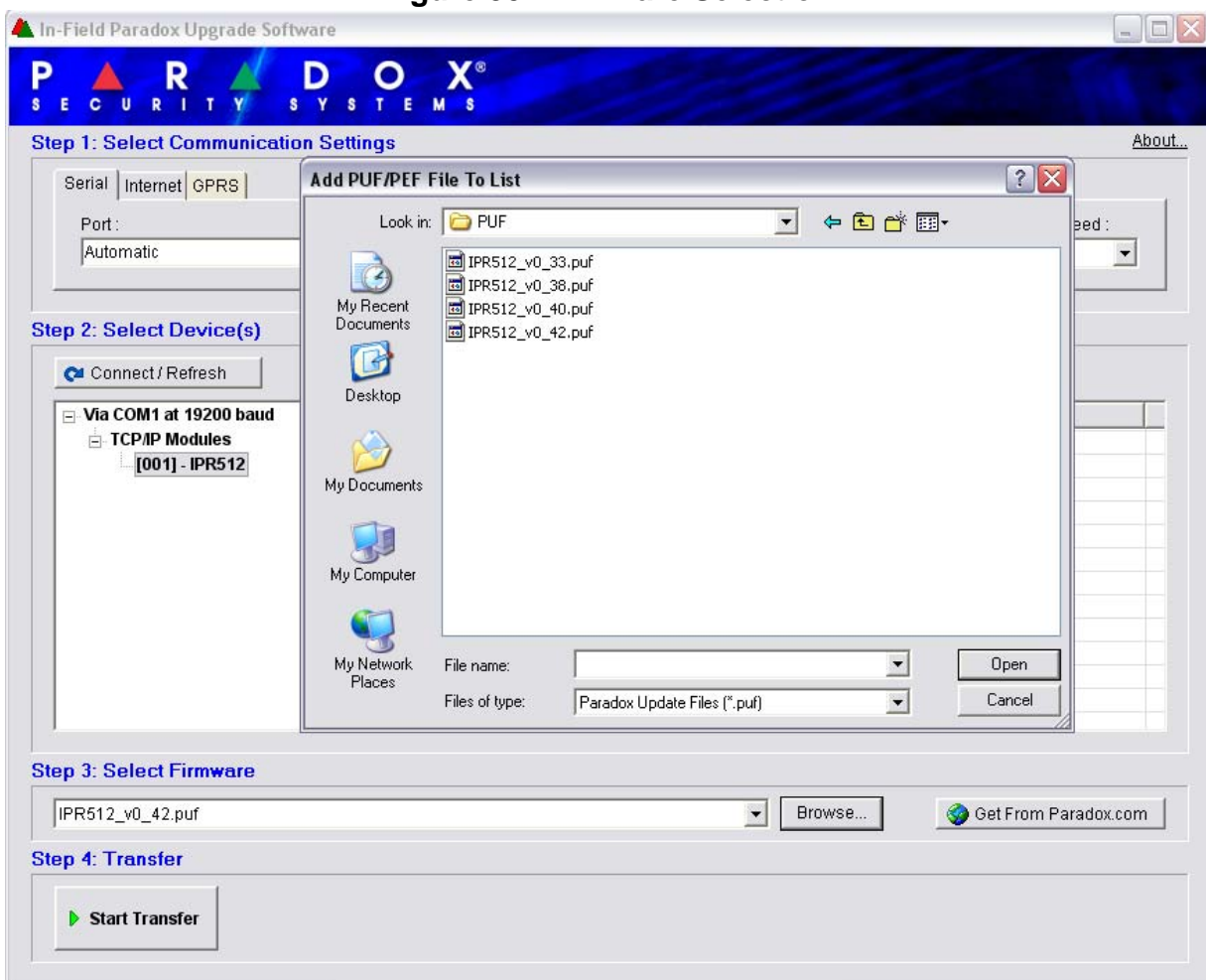

## Step 4: Transfer

1. Press the **Start Transfer** button. The system will then display a Progress dialog box.
2. Exit the application once the upgrade is complete.

**Figure 51: Transfer Process**

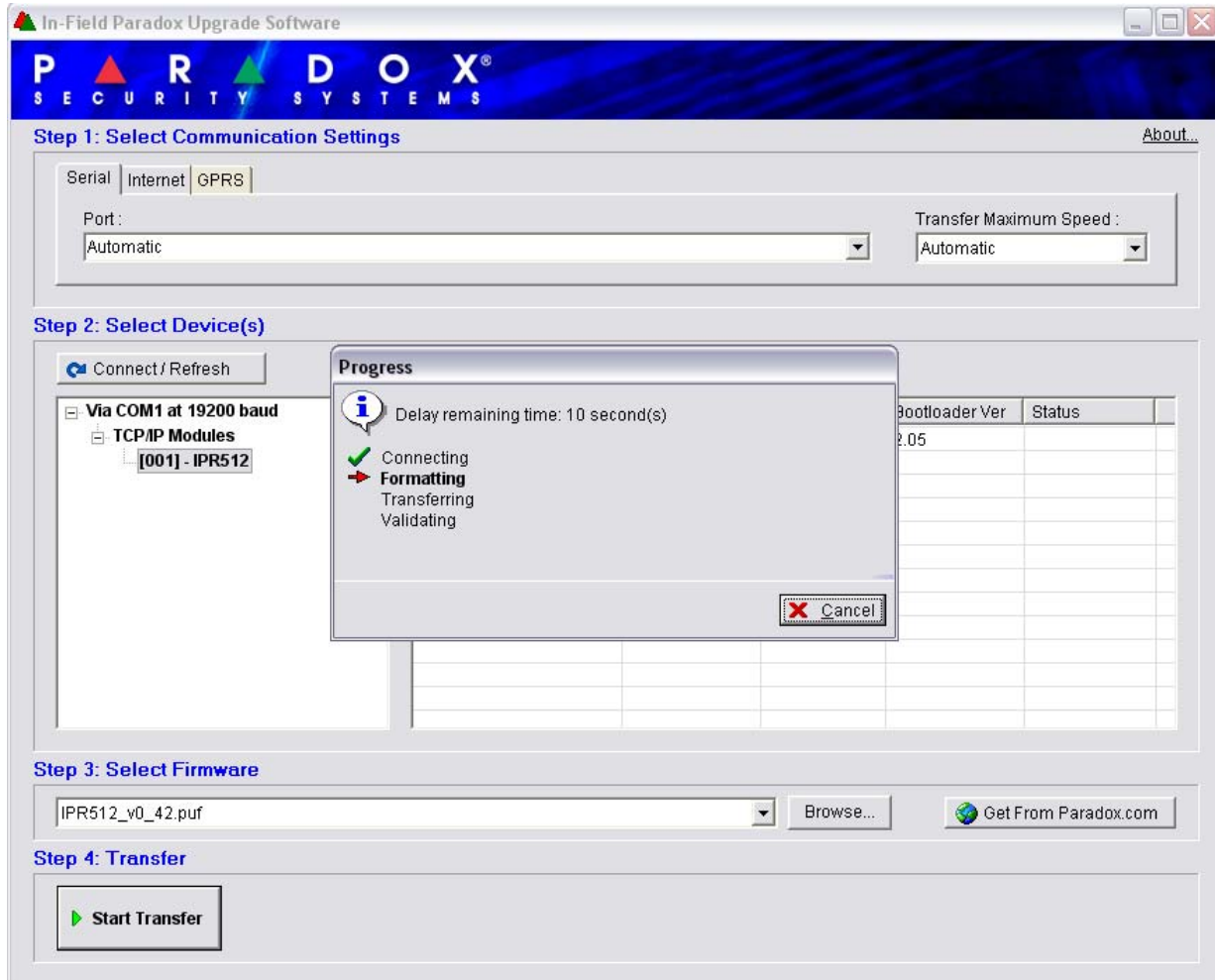

## To Upgrade Firmware Via the Network

Before beginning the upgrade process, ensure that the PC is connected to the network and that the **Internet** Tab is selected from the In-Field Paradox Upgrade Software window.

### Step 1: Define Communication Settings

1. Enter the IP address of the IPR512 Receiver or IP Module you wish to upgrade. If you do not have this information, then press the **Search** button and select product from the list. Selecting search will display the a list of the receivers that are currently connected to the same LAN as the PC that the In-Field application is installed on.
2. Define the Upgrade Port to be used in the Port field. This must match the upgrade port defined in the IPR512 Receiver Account Management System, under the Receiver Configuration menu.
3. Enter password in the Password field. The default password is admin.
4. Proceed to Step 2.

**Note:** If you have modified the default password setting in the IPR512 Receiver Account Management System, enter the current password.

**Figure 52: Communication Settings**

The screenshot displays the 'In-Field Paradox Upgrade Software' window. The title bar includes the Paradox Security Systems logo and the text 'In-Field Paradox Upgrade Software'. The main interface is divided into four steps:

- Step 1: Select Communication Settings**: This section has three tabs: 'Serial', 'Internet' (selected), and 'GPRS'. It features a search icon, an 'IP address' field with '192.168. 0 . 1', a 'Site ID' dropdown, a 'Port' field with '10000', and a 'Password' field with '\*\*\*\*\*'. An 'About...' link is in the top right.
- Step 2: Select Device(s)**: Contains a 'Connect / Refresh' button and a table with columns: Product (Family), Firmware Ver, SN, Bootloader Ver, and Result. The table is currently empty.
- Step 3: Select Firmware**: Includes a dropdown menu, a 'Browse...' button, and a 'Get From Paradox.com' button.
- Step 4: Transfer**: Contains a 'Start Transfer' button.

At the bottom, a legal notice states: 'One or more of the following US patents may apply; 7046142, 6215399, 6111256, 6104319, 5920259, 5886632, 5721542, 5287111, 5119069, 5077549 and RE39406. Canadian and international patents may also apply.'

## Step 2: Select Devices

1. Press the **Connect/Refresh** button. A Progress dialog box will appear. The progress dialog box detects the connection to the network in order to display results.
2. Select the Product to update from the list.
3. Proceed to Step 3.

**Figure 53: Select Devices**

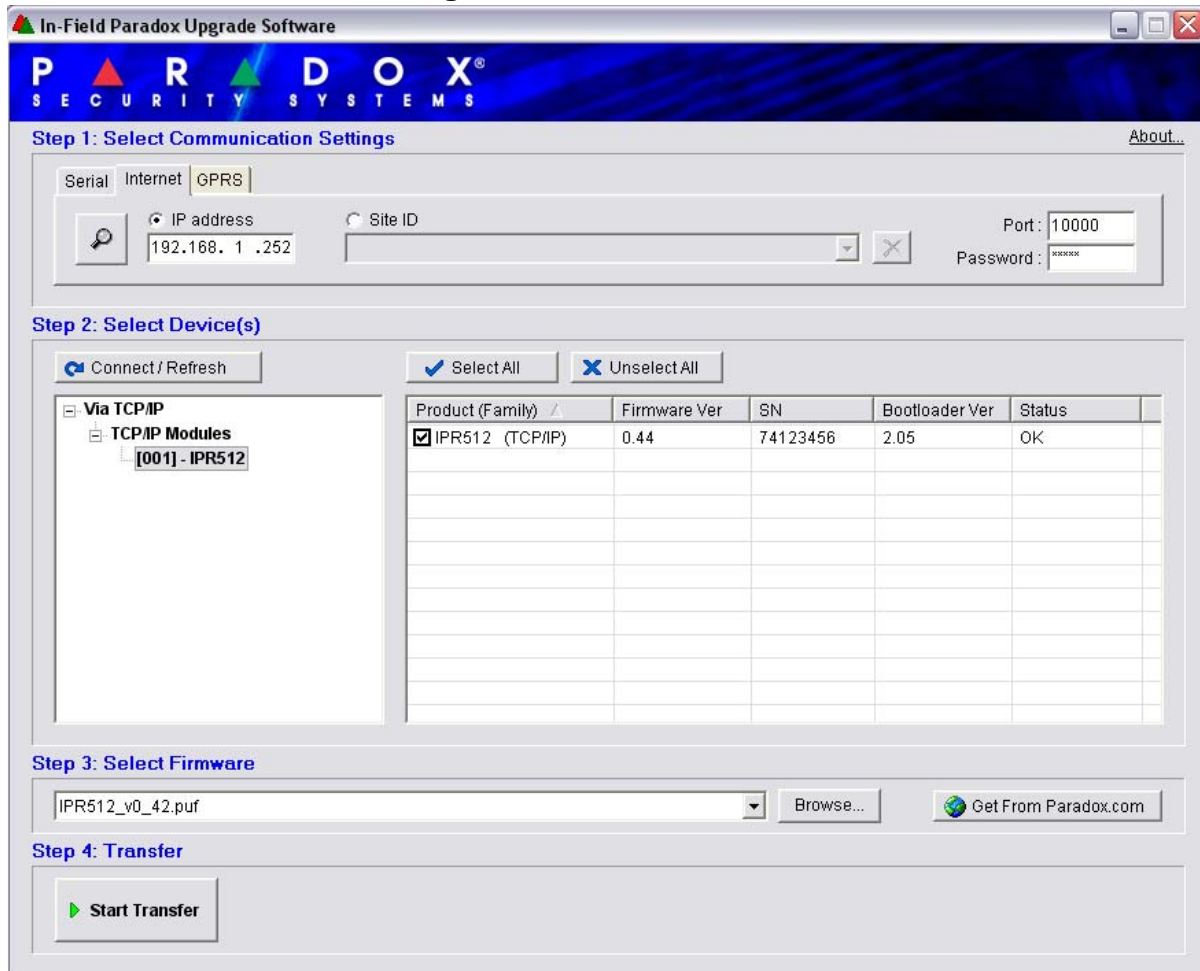



### Step 3: Select Firmware

1. Select the firmware version upgrade from the list. If the firmware version displayed in the Select Firmware window is the most recent, proceed to Step 4.
2. Press **Browse** to locate a file in another location, upgrade files have a “.puf” extension. Select the file from the Browse window. Once the file is selected, it will be displayed in the Select Firmware window. Select **Get From Paradox.com** to download the latest firmware upgrade directly from the Paradox website.
3. Proceed to Step 4.

**Note:** If you select a version that is older than the one currently installed on the IPR512 Receiver, the system will display a warning stating that you are about to transfer an older firmware version.

**Figure 54: Firmware Selection**

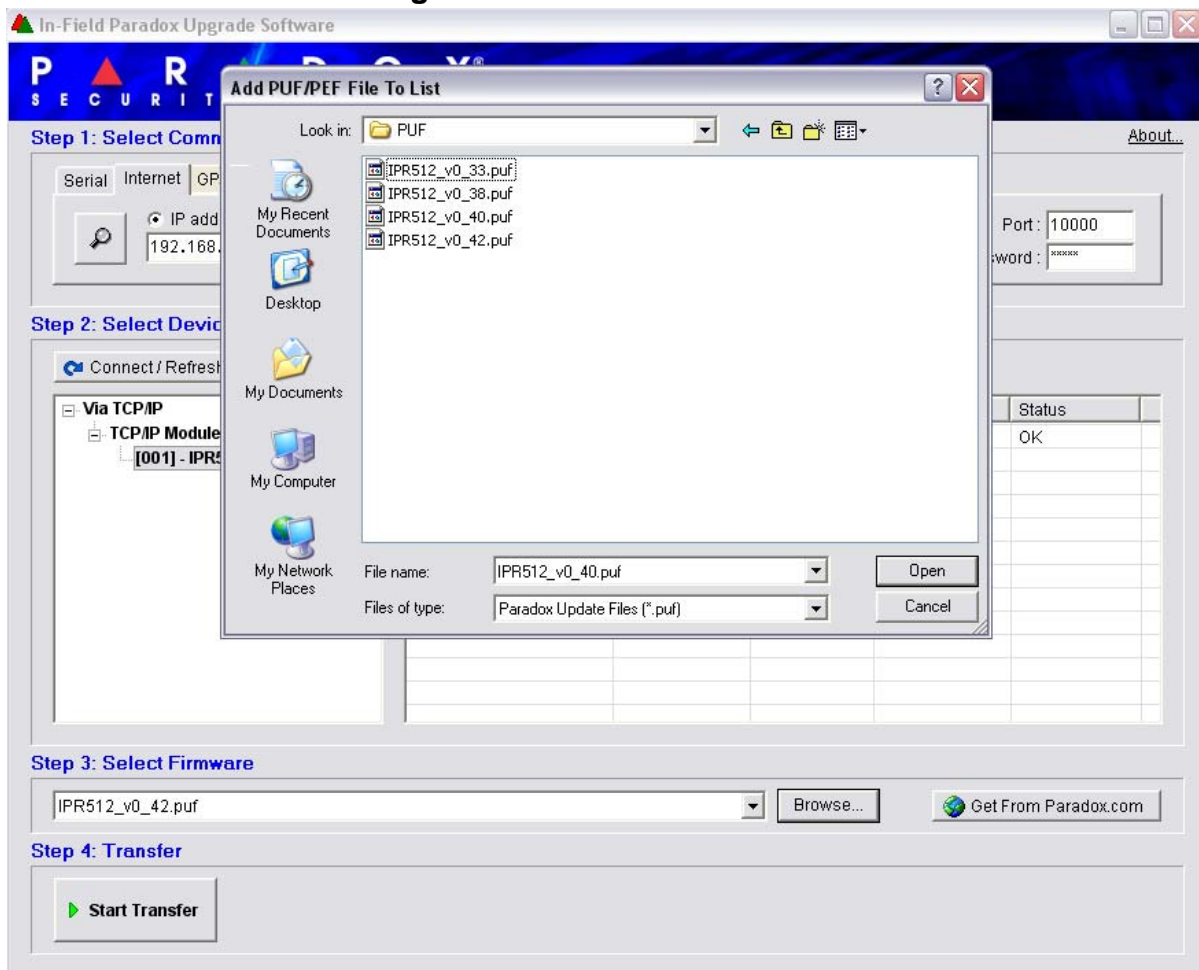

## Step 4: Transfer

1. Press the **Start Transfer** button. The system will then display a Progress dialog box.
2. Exit the application once the upgrade is complete.

**Figure 55: Transfer Process**

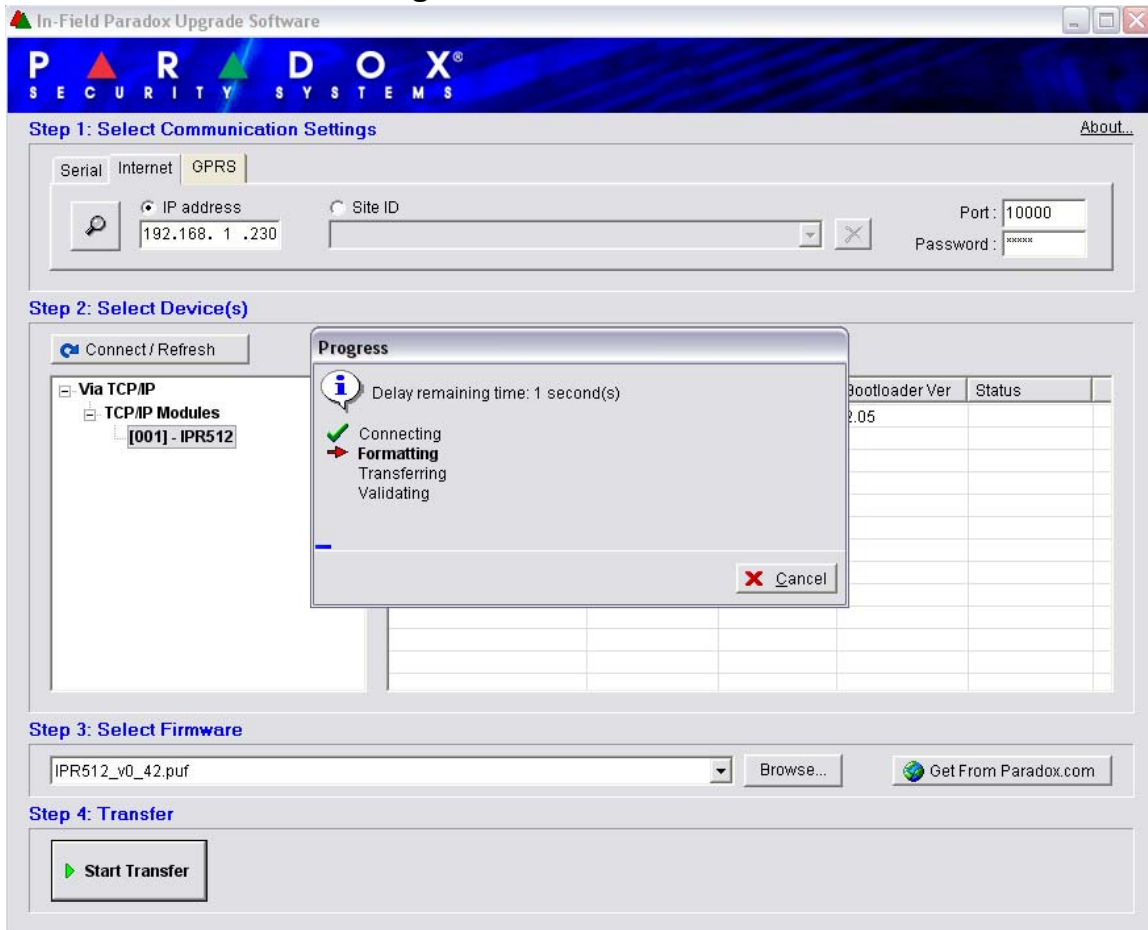

## Chapter 8: Initiating Communication with the IPR512 Receiver

Once the installation and configuration settings have been completed, the next step is to register the Paradox reporting modules to the IPR512 Receiver.

### Registering the Paradox Reporting Modules

No monitoring station operator action is required to register an Paradox reporting module. Registration is initiated by the installer upon installation of the Paradox reporting module. However, the monitoring station must provide the installer with the following information that is entered by the installer.

- **Account #** for each partition of the site.
- **IP Address** and **Port** of the IPR512 Receiver(s) you wish that the site to report to.
- **Receiver Password** (1 to 32 digits). For more information on setting the Receiver Password, refer to “Receiver Configuration Menu” on page 32.
- **Security Profile** (2 digits). For more information on Security Profiles, refer to “Security Profiles Menu” on page 28.

Once the installer has entered this information, the installer then initiates communication with the IPR512 Receiver and the Paradox reporting module will be automatically registered in the receiver.

# Index

---

## Numerics

19" Rack .....	10
32 polling profiles .....	26
6-Button Keypad Interface .....	14, 46

## A

AC .....	44
AC Input .....	9
AC Power Cable .....	15
AC Power Status LED .....	8
Account # .....	23, 39
Account cannot register, database is full .....	35
Account database reached 100% .....	35
Account database reached 75% .....	35
Account deleted .....	34
Account Registration .....	34
Account Status Icon .....	23
Account Supervision Loss .....	34, 35
Account Supervision Restore .....	34
Accounts using this profile .....	27
ACK/NACK protocol .....	31
Activate .....	20
Add a Security Profile .....	27
Address Bar .....	16
Automatic Update Verification Process .....	48
Automation software communication failure .....	35
Automation software communication restore .....	35

## B

Backlight .....	43
Backup Procedures .....	44
Backup restore from memory card .....	35
Backups .....	46
Baud rate .....	31
Bootloader .....	38

## C

CAT5 Network Cable .....	13
Change Password .....	21, 22
Code .....	34, 36
COM Ports .....	31
COM1 Port .....	9
COM2 Port .....	9
Communication Settings .....	49, 53
Confirm .....	22
Connections	
COM1 .....	12
COM2 .....	13
LAN Port .....	13
Power .....	15
WAN ports .....	14
Contrast .....	43
Control Keypad .....	8

Create Login .....	19
Critical Errors .....	44
Current .....	22

## D

Data .....	44
Data Backup .....	14
Data Bits .....	31
Data Status LED .....	8
Daylight Savings Time .....	32
Delete an Existing Account .....	25
Delete an Existing Security Profile .....	29
Demo Mode .....	18
Desktop Mounting Feet .....	8
Devices .....	50, 54
Dimensions .....	7
DNS primary .....	31
DNS secondary .....	31

## E

Enabled .....	36
Event Configuration Menu .....	33
Event Description .....	34, 36, 37, 38
EVO192 .....	6
EVO48 .....	6
EVO64 Keypads .....	6
Export Logged Events .....	38

## F

Firmware .....	44
Firmware Current Version .....	38
Firmware Latest Version .....	38
Firmware Upgrade .....	44, 48
Firmware Upgrade via the Network .....	53
Flow .....	31

## G

Gateway .....	31
---------------	----

## H

Hardware .....	38
----------------	----

## I

ID .....	27
In-Field Paradox Upgrade Software .....	48, 53
Info .....	21
Input .....	7
Input Power .....	7
Input Triggers .....	9
Input Voltage .....	7
Interface Enabled .....	31
Internet Tab .....	53
IP Address .....	31, 42

IP device .....	39
IP Module .....	48
IP100 .....	6
IPR512 power up .....	35
IPR512 Receiver	
Dimensions .....	7
Environmental Requirements .....	12
Software Compatibility .....	6
IPR512 Receiver Account Management System	16, 21

## L

LAN .....	9, 38, 44
LAN Interfaces .....	13
LAN network connection failure .....	35
LAN network connection restore .....	35
LAN Status LED .....	8
Last IP address .....	39
Last Poll time .....	23, 39
LCD .....	15, 44
LCD Configuration .....	42
LCD Display .....	8
LCD Programming Screens .....	16
LED Status Indicators .....	44
Line # .....	31
Login .....	19
Login Name .....	22
Logout .....	21

## M

MAC address .....	23, 39
MAC address - LAN .....	38
MAC address - WAN1 .....	38
MAC address - WAN2 .....	38
Main Menu .....	21
Manual Time Zone .....	32
MAXIMUS .....	6
Memory .....	38
Memory card error .....	35
Memory card not present .....	35
Memory card restore .....	35
Memory Card Slot .....	8
Menu Display .....	21
Modify an Existing Account .....	24
Modify an Existing Security Profile .....	28
Modify an Supervision Loss Event Code	34, 36, 38
Module Polling Time .....	27

## N

Name .....	27
Netmask .....	31
New .....	22
New Lan Settings Saved .....	42
NTP server .....	31
NTP server failure .....	35
NTP server restore .....	35

## O

On/Off Switch .....	15
Operating Temperature .....	7
Other Configuration .....	31
Output Format .....	31
Output Relay .....	9
Output Voltage .....	7

## P

Package Contents .....	3
Page Selector .....	21
Panel .....	23, 39
Parity .....	31
Password .....	22, 42, 46, 47, 53
PCS100 GPRS Module .....	6
Periodic Interval .....	31
Periodic Test Message .....	31
Permanently Delete a Deleted Account .....	41
Polling Profiles .....	26
Polling Web Site .....	31
Port .....	31, 42
Power Switch .....	9
Power Up .....	15
Protocol Header .....	31
Protocol Trailer .....	31

## R

Rack-Mounting Bracket .....	8
Receiver Configuration .....	31
Receiver Configuration Menu .....	30
Receiver Events .....	35
Receiver ID .....	31
Receiver Password .....	31
Receiver Status menu .....	37
Receiver Supervision Time .....	27
Register .....	18
Registered on .....	38, 39
Registration Login Page .....	19
Restore .....	46, 47
Restore a Deleted Account .....	40

## S

Save .....	22
SD Memory Card .....	14
Search .....	21
Security Profiles .....	23, 39
Security Profiles Menu .....	26
Select Firmware .....	51, 55
Serial .....	38, 44
Serial Port Status LED .....	8
Set backlight .....	43
Set Contrast .....	43
SIA .....	34
SIMS II .....	6

Software Compatibility .....	6
Special Event Reporting .....	32
Start Transfer .....	52, 56
Start-up .....	15
Stop Bits .....	31
Subnet Mask .....	42
System Backup .....	46
System Components .....	8, 9
System Configuration .....	16
System Log File .....	38

## T

temporary storage .....	39
Time Zone .....	32
Transfer .....	52, 56
Trouble group .....	37
Trouble Status LED .....	8
Troubles .....	37, 44
Troubleshooting .....	44

## U

Upgrade port .....	31
--------------------	----

## V

View Troubles .....	44
View/Restore Deleted Accounts Menu .....	39

## W

WAN1 .....	9, 38, 44
WAN1 internet connection failure .....	35
WAN1 internet connection restore .....	35
WAN1 network connection failure .....	35
WAN1 network connection restore .....	35
WAN1 Status LED .....	8
WAN2 .....	9, 38, 44
WAN2 internet connection failure .....	36
WAN2 internet connection restore .....	36
WAN2 network connection failure .....	35
WAN2 network connection restore .....	36
Web Browser .....	16
Web login .....	35
WINSAMM .....	6



We hope this product performs to your complete satisfaction.  
Should you have any questions or comments, please visit us at [www.paradox.com](http://www.paradox.com).

